

LENTE PROMOTIE

2026

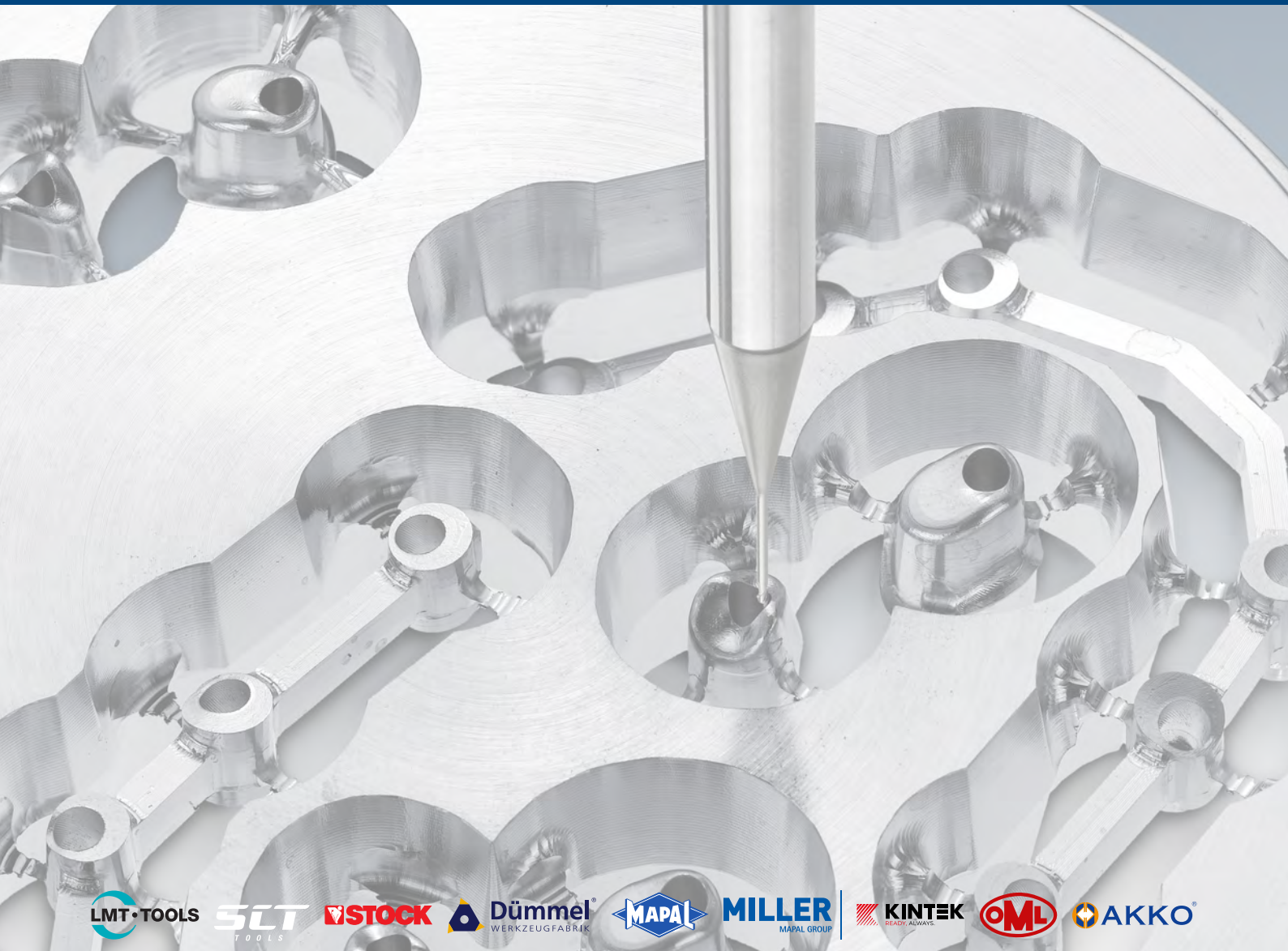

Primair geautoriseerde dealer

Uw partner in efficiënt produceren

Prijzen exclusief BTW geldig t/m 30 juni 2026

© Druk- en zetfouten voorbehouden.

HAGRO
| precisie bv

Stock VHM boren SuperV-AL IK 5xD 71791 voor nonferro's



N

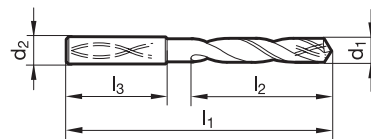

D1	D2	L1	L2	L3	Artikel	Bruto	Netto	D1	D2	L1	L2	L3	Artikel	Bruto	Netto
3,0	6	66	28	36	7179103000	€ 55,45	€ 43,50	7,2	8	91	53	36	7179107200	€ 66,45	€ 52,10
3,1	6	66	28	36	7179103100	€ 55,45	€ 43,50	7,3	8	91	53	36	7179107300	€ 66,45	€ 52,10
3,2	6	66	28	36	7179103200	€ 55,45	€ 43,50	7,4	8	91	53	36	7179107400	€ 66,45	€ 52,10
3,3	6	66	28	36	7179103300	€ 55,45	€ 43,50	7,5	8	91	53	36	7179107500	€ 66,45	€ 52,10
3,4	6	66	28	36	7179103400	€ 55,45	€ 43,50	7,6	8	91	53	36	7179107600	€ 66,45	€ 52,10
3,5	6	66	28	36	7179103500	€ 55,45	€ 43,50	7,7	8	91	53	36	7179107700	€ 66,45	€ 52,10
3,6	6	66	28	36	7179103600	€ 55,45	€ 43,50	7,8	8	91	53	36	7179107800	€ 66,45	€ 52,10
3,7	6	66	28	36	7179103700	€ 55,45	€ 43,50	7,9	8	91	53	36	7179107900	€ 66,45	€ 52,10
3,8	6	74	36	36	7179103800	€ 55,45	€ 43,50	8,0	8	91	53	36	7179108000	€ 66,45	€ 52,10
3,9	6	74	36	36	7179103900	€ 55,45	€ 43,50	8,1	10	103	61	40	7179108100	€ 75,70	€ 59,40
4,0	6	74	36	36	7179104000	€ 59,55	€ 46,70	8,2	10	103	61	40	7179108200	€ 75,70	€ 59,40
4,1	6	74	36	36	7179104100	€ 59,55	€ 46,70	8,3	10	103	61	40	7179108300	€ 75,70	€ 59,40
4,2	6	74	36	36	7179104200	€ 59,55	€ 46,70	8,4	10	103	61	40	7179108400	€ 75,70	€ 59,40
4,3	6	74	36	36	7179104300	€ 59,55	€ 46,70	8,5	10	103	61	40	7179108500	€ 75,70	€ 59,40
4,4	6	74	36	36	7179104400	€ 59,55	€ 46,70	8,6	10	103	61	40	7179108600	€ 75,70	€ 59,40
4,5	6	74	36	36	7179104500	€ 59,55	€ 46,70	8,7	10	103	61	40	7179108700	€ 75,70	€ 59,40
4,6	6	74	36	36	7179104600	€ 59,55	€ 46,70	8,8	10	103	61	40	7179108800	€ 75,70	€ 59,40
4,7	6	74	36	36	7179104700	€ 59,55	€ 46,70	8,9	10	103	61	40	7179108900	€ 75,70	€ 59,40
4,8	6	82	44	36	7179104800	€ 59,55	€ 46,70	9,0	10	103	61	40	7179109000	€ 75,70	€ 59,40
4,9	6	82	44	36	7179104900	€ 59,55	€ 46,70	9,1	10	103	61	40	7179109100	€ 75,70	€ 59,40
5,0	6	82	44	36	7179105000	€ 59,55	€ 46,70	9,2	10	103	61	40	7179109200	€ 75,70	€ 59,40
5,1	6	82	44	36	7179105100	€ 59,55	€ 46,70	9,3	10	103	61	40	7179109300	€ 75,70	€ 59,40
5,2	6	82	44	36	7179105200	€ 59,55	€ 46,70	9,4	10	103	61	40	7179109400	€ 75,70	€ 59,40
5,3	6	82	44	36	7179105300	€ 59,55	€ 46,70	9,5	10	103	61	40	7179109500	€ 75,70	€ 59,40
5,4	6	82	44	36	7179105400	€ 59,55	€ 46,70	9,6	10	103	61	40	7179109600	€ 75,70	€ 59,40
5,5	6	82	44	36	7179105500	€ 59,55	€ 46,70	9,7	10	103	61	40	7179109700	€ 75,70	€ 59,40
5,6	6	82	44	36	7179105600	€ 59,55	€ 46,70	9,8	10	103	61	40	7179109800	€ 75,70	€ 59,40
5,7	6	82	44	36	7179105700	€ 59,55	€ 46,70	9,9	10	103	61	40	7179109900	€ 75,70	€ 59,40
5,8	6	82	44	36	7179105800	€ 59,55	€ 46,70	10,0	10	103	61	40	7179110000	€ 75,70	€ 59,40
5,9	6	82	44	36	7179105900	€ 59,55	€ 46,70	10,5	12	118	71	45	7179110500	€ 109,85	€ 86,20
6,0	6	82	44	36	7179106000	€ 59,55	€ 46,70	11,0	12	118	71	45	7179111000	€ 109,85	€ 86,20
6,1	8	91	53	36	7179106100	€ 66,45	€ 52,10	12,0	12	118	71	45	7179112000	€ 109,85	€ 86,20
6,2	8	91	53	36	7179106200	€ 66,45	€ 52,10	12,5	14	124	77	45	7179112500	€ 147,30	€ 115,50
6,3	8	91	53	36	7179106300	€ 66,45	€ 52,10	13,0	14	124	77	45	7179113000	€ 147,30	€ 115,50
6,4	8	91	53	36	7179106400	€ 66,45	€ 52,10	14,0	14	124	77	45	7179114000	€ 147,30	€ 115,50
6,5	8	91	53	36	7179106500	€ 66,45	€ 52,10	15,0	16	133	83	48	7179115000	€ 183,40	€ 143,80
6,6	8	91	53	36	7179106600	€ 66,45	€ 52,10	16,0	16	133	83	48	7179116000	€ 183,40	€ 143,80
6,7	8	91	53	36	7179106700	€ 66,45	€ 52,10	16,5	18	143	93	48	7179116500	€ 292,10	€ 229,30
6,8	8	91	53	36	7179106800	€ 66,45	€ 52,10	17,0	18	143	93	48	7179117000	€ 292,10	€ 229,30
6,9	8	91	53	36	7179106900	€ 66,45	€ 52,10	18,0	18	143	93	48	7179118000	€ 292,10	€ 229,30
7,0	8	91	53	36	7179107000	€ 66,45	€ 52,10	19,0	20	153	101	50	7179119000	€ 318,63	€ 249,90
7,1	8	91	53	36	7179107100	€ 66,45	€ 52,10	20,0	20	153	101	50	7179120000	€ 318,63	€ 249,90

Stock draadfrezen 4xD volhardmetaal TM-SP 53894 AlTiZrN

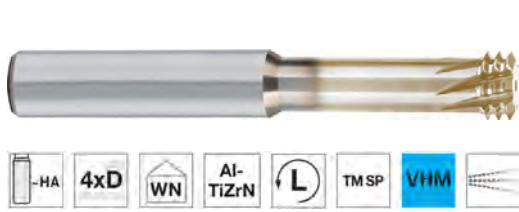

P K M S N

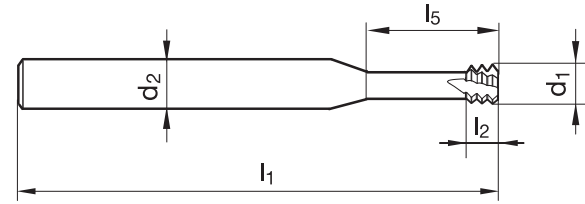

Maat	Spood	D2	L2	L5	L1	Z	Artikel	Bruto	Netto
M2	0,40	3	3	8	39	4	5389402000	€ 108,50	€ 87,40
M2,5	0,45	3	3,4	10	39	4	5389402500	€ 108,50	€ 87,40
M3	0,50	3	3,5	12,5	39	4	5389403000	€ 108,50	€ 87,40
M4	0,70	6	5	16,5	58	4	5389404000	€ 111,55	€ 89,90
M5	0,80	6	6	20,5	58	4	5389405000	€ 111,55	€ 89,90
M6	1,00	8	7	24,5	73	6	5389406000	€ 111,55	€ 89,90
M8	1,25	8	9	32,5	73	6	5389408000	€ 111,55	€ 89,90
M10	1,50	10	11	40,5	84	6	5389410000	€ 121,04	€ 97,50
M12	1,75	12	13	48,5	100	6	5389412000	€ 157,25	€ 126,70
M16	2,00	14	13	64,5	115	6	5389416000	€ 180,30	€ 145,30
M20	2,50	16	16	80,5	130	6	5389420000	€ 201,55	€ 234,90

SCT hardmetaal vingerfrezen met speciale kopslijping VND



P K M S H

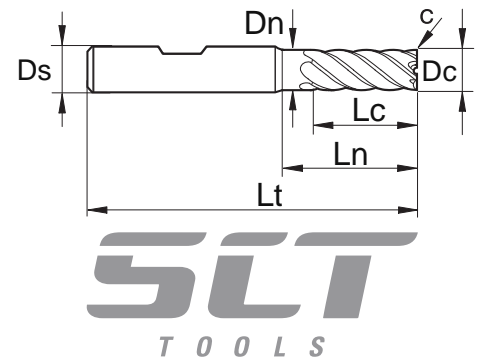

Dc	Ds	Lc	Ln	Dn	Lt	C	Z	Artikel	Bruto	Netto
5,7	6	13	19	5,4	57	0,05	4	BLW4L05738VND	€ 30,65	€ 24,60
6,0	6	13	19	5,7	57	0,06	4	BLW4L06038VND	€ 30,65	€ 24,60
7,7	8	19	25	7,3	63	0,07	4	BLW4L07738VND	€ 43,20	€ 34,60
8,0	8	19	25	7,6	63	0,08	4	BLW4L08038VND	€ 43,20	€ 34,60
9,7	10	22	30	9,2	72	0,09	4	BLW4L09738VND	€ 68,65	€ 55,00
10,0	10	22	30	9,5	72	0,10	4	BLW4L10038VND	€ 68,65	€ 55,00
11,7	12	26	36	11,2	83	0,11	4	BLW4L11738VND	€ 97,80	€ 78,30
12,0	12	26	36	11,5	83	0,12	4	BLW4L12038VND	€ 97,80	€ 78,30
13,7	14	26	36	13,2	83	0,13	4	BLW4L13738VND	€ 129,80	€ 103,90
14,0	14	26	36	13,5	83	0,14	4	BLW4L14038VND	€ 129,80	€ 103,90
15,6	16	32	42	15,1	92	0,15	4	BLW4L15638VND	€ 171,90	€ 137,60
16,0	16	32	42	15,5	92	0,16	4	BLW4L16038VND	€ 171,90	€ 137,60
19,5	20	38	52	19,0	104	0,19	4	BLW4L19538VND	€ 282,60	€ 226,00
20,0	20	38	52	19,5	104	0,20	4	BLW4L20038VND	€ 282,60	€ 226,00

Gewijzigd (hardmetaal toeslag)

LMT Tools EasyTap EGM HeliCoil blind



P M N K

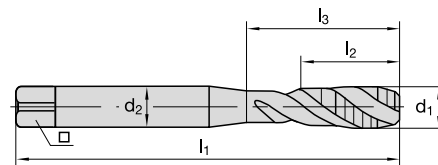

EGM EASY. h9 2-3xD 45° E 1.5-2 6HX mod HSS-E TiN

D1	P	L1	L2	L3	D2	Vierkant	Z	Boor	Artikel	Bruto	Netto
EGM2	0,40	50	4,5	13	2,8	2,1	2	2,10	7465499	€15,15	€11,40
EGM2,5	0,45	56	5	18	3,5	2,7	3	2,65	7465500	€15,45	€11,60
EGM3	0,50	63	5	21	4,5	3,4	3	3,15	7465501	€16,85	€12,70
EGM4	0,70	70	7	25	6	4,9	3	4,20	7465502	€17,00	€12,80
EGM5	0,80	80	8	30	6	4,9	3	5,25	7465503	€17,75	€13,40
EGM6	1,00	90	10	35	8	6,2	3	6,30	7465504	€18,55	€14,00
EGM8	1,25	100	13	39	10	8	3	8,40	7465505	€20,90	€15,70
EGM10	1,50	100	15	-	9	7	3	10,5	7465506	€25,65	€19,30
EGM12	1,75	110	18	-	11	9	3	12,5	7465507	€32,60	€24,50
EGM16	2,00	125	20	-	14	11	4	16,5	7465508	€40,55	€37,20
EGM20	2,50	160	25	-	18	14,5	4	20,5	7465509	€79,85	€59,90

LMT Tools EasyTap EGM HeliCoil doorlopend



P M N K

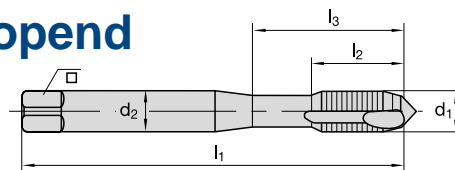

EGM EASY. h9 3xD 0° B 3,5-5,1 6HX mod HSS-E TiN

D1	P	L1	L2	L3	D2	Vierkant	Z	Boor	Artikel	Bruto	Netto
EGM2	0,40	50	9	-	2,8	2,1	2	2,10	7465488	€15,15	€11,40
EGM2,5	0,45	56	11	18	3,5	2,7	3	2,65	7465489	€15,35	€11,60
EGM3	0,50	63	13	21	4,5	3,4	3	3,15	7465490	€16,00	€12,00
EGM4	0,70	70	16	25	6	4,9	3	4,20	7465491	€16,30	€12,30
EGM5	0,80	80	19	30	6	4,9	3	5,25	7465492	€16,95	€12,80
EGM6	1,00	90	22	35	8	6,2	3	6,30	7465493	€17,65	€13,30
EGM8	1,25	100	24	39	10	8,0	3	8,40	7465494	€19,95	€15,00
EGM10	1,50	100	29	-	9	7,0	3	10,5	7465495	€24,15	€18,20
EGM12	1,75	110	30	-	11	9,0	3	12,5	7465496	€30,80	€23,10
EGM16	2,00	125	34	-	14	11,0	3	16,5	7465497	€46,85	€35,20
EGM20	2,50	160	34	-	18	14,5	3	20,5	7465498	€75,65	€56,80

Kintek tappotten grootte 1 en 2 zonder slipkoppeling



Schacht	Vierkant	IBC	Artikel	Netto
2,80	2,10	1	IBC1-2.8X2.1	€20,00
3,50	2,70	1	IBC1-3.5X2.7	€20,00
4,50	3,40	1	IBC1-4.5X3.4	€20,00
6,00	4,90	1	IBC1-6X4.9	€20,00
8,00	6,20	1	IBC1-8X6.2	€20,00
9,00	7,00	1	IBC1-9X7	€20,00
11,00	9,00	1	IBC1-11X9	€20,00

Schacht	Vierkant	IBC	Artikel	Netto
6,00	4,90	2	IBC2-6X4.9	€29,00
8,00	6,20	2	IBC2-8X6.2	€29,00
9,00	7,00	2	IBC2-9X7	€29,00
10,00	8,00	2	IBC2-10X8	€29,00
11,00	9,00	2	IBC2-11X9	€29,00
14,00	11,00	2	IBC2-14X11	€29,00
18,00	14,50	2	IBC2-18X14.5	€29,00

LMT Tools VHM 2-snijder microfrezes MIC01-H-A



P H

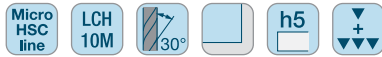
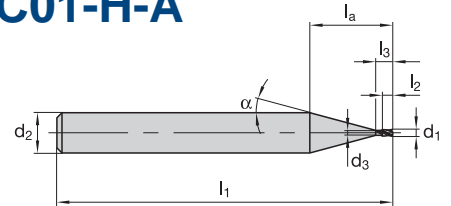

D1	L2	L1	L3	La	D2	D3	Z	Lc	Artikel	Bruto	Netto
0,3	0,4	50	0,4	16,6	6	-	2	XS	7434427	€ 33,60	€ 26,40
0,4	0,6	50	0,6	16,5	6	-	2	XS	7434428	€ 34,90	€ 27,40
0,5	0,7	50	1,5	11,9	6	0,44	2	XS	7434430	€ 36,80	€ 28,90
0,6	0,9	50	1,8	12,0	6	0,54	2	XS	7434431	€ 38,10	€ 29,90
0,8	1,2	50	2,4	12,2	6	0,74	2	XS	7434433	€ 38,10	€ 29,90
1,0	1,5	50	2,5	12,3	6	0,74	2	XS	7434435	€ 31,40	€ 24,70
1,2	1,8	50	3,0	12,0	6	1,14	2	XS	7434437	€ 37,45	€ 29,40
1,4	2,1	50	3,5	12,2	6	1,34	2	XS	7434439	€ 37,45	€ 29,40
1,5	2,3	50	3,5	12,2	6	1,34	2	XS	7434441	€ 36,80	€ 28,90
1,6	2,4	50	4,0	12,3	6	1,55	2	XS	7434443	€ 36,80	€ 28,90
1,8	2,7	50	4,5	12,4	6	1,75	2	XS	7434445	€ 36,80	€ 28,90
2,0	3,0	50	5,0	12,6	6	1,94	2	XS	7434447	€ 41,60	€ 32,70
2,5	3,7	50	5,0	11,7	6	2,40	2	XS	7434449	€ 36,80	€ 28,90
0,5	0,7	60	2,5	12,9	6	0,44	2	S	7434429	€ 34,90	€ 27,40
0,8	1,2	60	4,0	13,8	6	0,74	2	S	7434432	€ 38,10	€ 29,90
1,0	1,5	60	5,0	14,4	6	0,94	2	S	7434434	€ 38,10	€ 29,90
1,2	1,8	60	6,0	15,1	6	1,14	2	S	7434436	€ 31,40	€ 24,70
1,4	2,1	60	7,0	15,7	6	1,34	2	S	7434438	€ 31,40	€ 24,70
1,5	2,3	60	7,5	16,0	6	1,44	2	S	7434440	€ 30,80	€ 24,20
1,6	2,4	60	8,0	16,3	6	1,54	2	S	7434442	€ 36,80	€ 28,90
1,8	2,7	60	9,0	16,9	6	1,74	2	S	7434444	€ 36,80	€ 28,90
2,0	3,0	60	10,0	17,6	6	1,94	2	S	7434446	€ 30,80	€ 24,20
2,5	3,7	60	12,5	19,1	6	2,44	2	S	7434448	€ 31,40	€ 24,70

LMT Tools VHM 3-snijder microfrees MIC01-U-A



P K M N

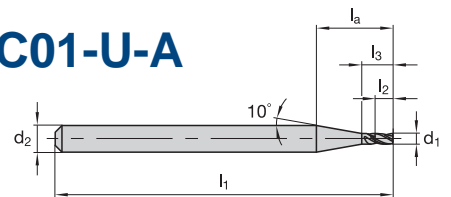

D1	L2	L1	L3	La	D2	D3	Z	Lc	Artikel	Bruto	Netto
0,5	1,5	38	2,2	9,3	3	-	3	S	7434450	€ 28,80	€ 22,60
0,6	1,5	38	2,3	9,1	3	-	3	S	7434451	€ 28,80	€ 22,60
0,8	1,5	38	2,6	8,8	3	-	3	S	7434452	€ 28,80	€ 22,60
1,0	2	38	3,2	8,9	3	-	3	S	7434453	€ 28,80	€ 22,60
1,2	2	38	3,5	8,6	3	-	3	S	7434454	€ 28,80	€ 22,60
1,5	2	38	3,7	8,0	3	-	3	S	7434455	€ 28,80	€ 22,60
2,0	8	38	10,0	12,8	3	-	3	S	7434456	€ 28,80	€ 22,60
2,5	9	38	11,5	12,9	3	-	3	S	7434457	€ 28,80	€ 22,60
3,0	12	38	12,0	17,0	3	-	3	S	7434458	€ 28,80	€ 22,60

Miller OptiMill-Uni-HPC-Rough VHM ruwfrees M3081 kort



P K M

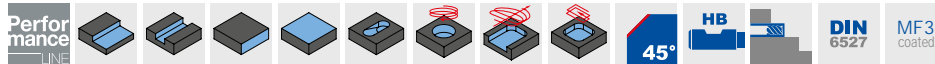
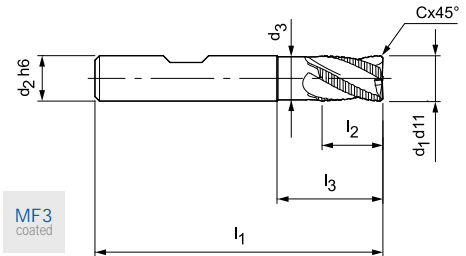

D1	D2	L1	L2	L3	Fase	Z	Type aanduiding	Artikel	Bruto	Netto
5	6	54	8	-	0,30	3	M3081-0500BY	30427454	€ 43,20	€ 33,00
6	6	54	8	18	0,30	3	M3081-0600BY	30427457	€ 43,20	€ 33,00
7	8	58	11	-	0,30	3	M3081-0700BY	30427458	€ 54,10	€ 42,00
8	8	58	11	22	0,30	3	M3081-0800BY	30427460	€ 54,10	€ 42,00
9	10	66	13	-	0,50	4	M3081-0900BY	30427461	€ 71,45	€ 54,00
10	10	66	13	26	0,50	4	M3081-1000BY	30427462	€ 71,45	€ 54,00
12	12	73	16	28	0,50	4	M3081-1200BY	30427464	€ 91,30	€ 69,00
14	14	76	16	31	0,50	4	M3081-1400BY	30427465	€ 108,25	€ 84,00
16	16	82	19	34	0,50	4	M3081-1600BY	30427466	€ 140,15	€ 108,00
18	18	84	19	36	0,50	4	M3081-1800BY	30427467	€ 182,25	€ 138,00
20	20	92	20	42	0,50	4	M3081-2000BY	30427468	€ 214,05	€ 163,00

Miller OptiMill-Uni-HPC-Rough VHM ruwfrees M3181 lang



P K M

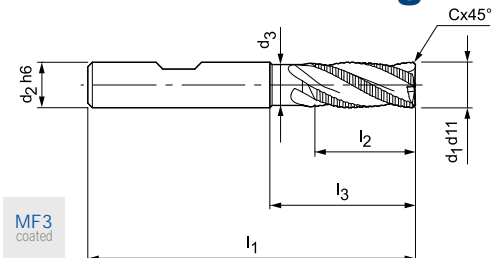

D1	D2	L1	L2	L3	Fase	Z	Type aanduiding	Artikel	Bruto	Netto
4	6	57	8	-	0,30	3	M3181-0400BY	30427427	€ 45,75	€ 35,00
5	6	57	13	-	0,30	3	M3181-0500BY	30427428	€ 45,75	€ 35,00
6	6	57	13	21	0,30	3	M3181-0600BY	30427430	€ 45,75	€ 35,00
7	8	63	16	-	0,30	3	M3181-0700BY	30427432	€ 59,90	€ 45,00
8	8	63	16	26	0,30	3	M3181-0800BY	30427433	€ 59,90	€ 45,00
9	10	72	19	-	0,50	4	M3181-0900BY	30427434	€ 77,00	€ 58,00
10	10	72	22	32	0,50	4	M3181-1000BY	30427437	€ 77,00	€ 58,00
11	12	83	26	-	0,50	4	M3181-1100BY	30427438	€ 99,35	€ 75,00
12	12	83	26	38	0,50	4	M3181-1200BY	30427439	€ 99,35	€ 75,00
13	14	83	26	-	0,50	4	M3181-1300BY	30427440	€ 119,70	€ 90,00
14	14	83	26	42	0,50	4	M3181-1400BY	30427441	€ 119,70	€ 90,00
16	16	92	32	44	0,50	4	M3181-1600BY	30427443	€ 161,85	€ 122,00
18	18	92	32	48	0,50	4	M3181-1800BY	30427444	€ 202,70	€ 153,00
20	20	104	38	54	0,50	4	M3181-2000BY	30427447	€ 239,24	€ 180,00
25	25	121	45	65	0,50	5	M3181-2500BY	30427448	€ 422,05	€ 317,00

Miller OptiMill-Uni-HPC-Finish 3xD VHM frees M3917-3D



P K M S H

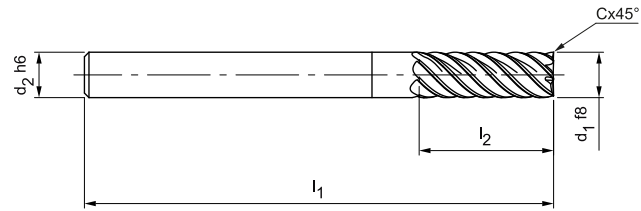

D1	D2	L1	L2	Fase	Z	Type aanduiding	Artikel	Bruto	Netto
4	6	62	16	0,04	7	M3917-3D-0400AY-C0004	30887641	€ 52,45	€ 40,00
5	6	62	17	0,05	7	M3917-3D-0500AY-C0005	30887642	€ 52,45	€ 40,00
6	6	62	18	0,06	7	M3917-3D-0600AY-C0006	30887643	€ 52,45	€ 40,00
8	8	68	24	0,08	7	M3917-3D-0800AY-C0008	30887644	€ 68,75	€ 52,00
10	10	80	30	0,10	7	M3917-3D-1000AY-C0010	30887645	€ 88,25	€ 68,00
12	12	93	36	0,12	7	M3917-3D-1200AY-C0012	30887646	€ 116,35	€ 88,00
14	14	99	42	0,14	7	M3917-3D-1400AY-C0014	30887647	€ 161,60	€ 122,00
16	16	108	48	0,16	7	M3917-3D-1600AY-C0016	30887648	€ 186,00	€ 140,00
20	20	126	60	0,20	7	M3917-3D-2000AY-C0020	30887650	€ 301,10	€ 226,00

Miller OptiMill-Uni-HPC-Finish 4xD VHM frees M3917-4D



P K M S H

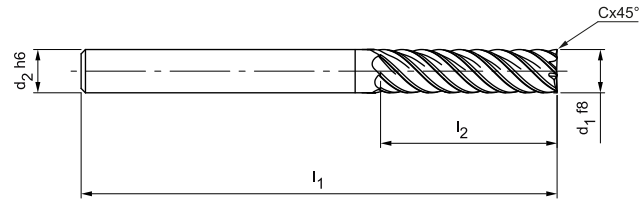

D1	D2	L1	L2	Fase	Z	Type aanduiding	Artikel	Bruto	Netto
6	6	66	24	0,06	7	M3917-4D-0600AY-C0006	30887652	€ 56,55	€ 44,00
8	8	74	32	0,08	7	M3917-4D-0800AY-C0008	30887653	€ 78,05	€ 60,00
10	10	89	40	0,10	7	M3917-4D-1000AY-C0010	30887654	€ 99,40	€ 76,00
12	12	100	48	0,12	7	M3917-4D-1200AY-C0012	30887655	€ 135,60	€ 102,00
14	14	108	56	0,14	7	M3917-4D-1400AY-C0014	30887656	€ 171,75	€ 130,00
16	16	123	64	0,16	7	M3917-4D-1600AY-C0016	30887657	€ 205,00	€ 154,00
20	20	140	80	0,20	7	M3917-4D-2000AY-C0020	30887659	€ 329,30	€ 248,00

Miller OptiMill-Uni-HPC-Finish 5xD VHM frees M3917-5D



P K M S H

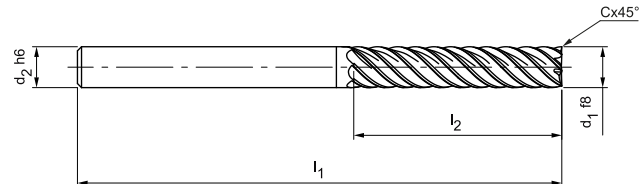

D1	D2	L1	L2	Fase	Z	Type aanduiding	Artikel	Bruto	Netto
8	8	81	40	0,08	7	M3917-5D-0800AY-C0008	30887661	€ 89,85	€ 68,00
10	10	96	50	0,10	7	M3917-5D-1000AY-C0010	30887662	€ 116,70	€ 88,00
12	12	112	60	0,12	7	M3917-5D-1200AY-C0012	30887663	€ 149,20	€ 113,00
14	14	122	70	0,14	7	M3917-5D-1400AY-C0014	30887664	€ 203,35	€ 153,00
16	16	136	80	0,16	7	M3917-5D-1600AY-C0016	30887665	€ 235,50	€ 177,00
20	20	160	100	0,20	7	M3917-5D-2000AY-C0020	30887667	€ 372,00	€ 280,00

OML V5 88-130 centrumspanner met 87,5mm bekbreedte

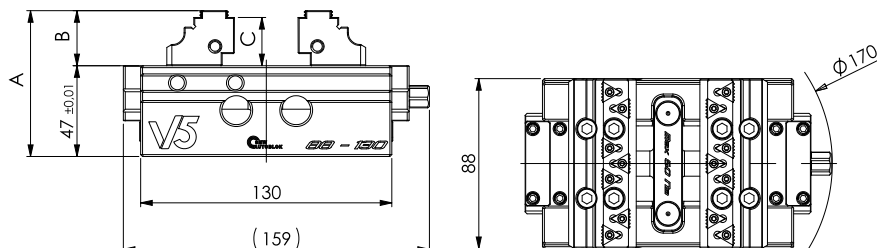

- Altijd zelfcentrerend
- Bekbreedte 87,5mm
- Spankracht tot 32 kN (50 Nm)
- Boringspatroon voor APS, TDM en Plus5 raster 52mm

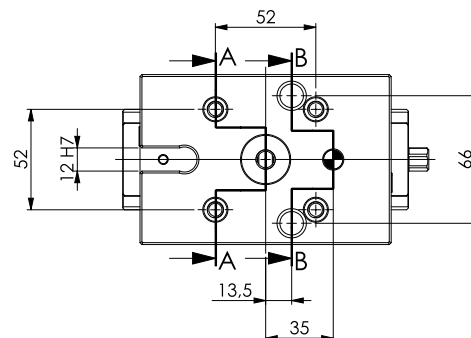
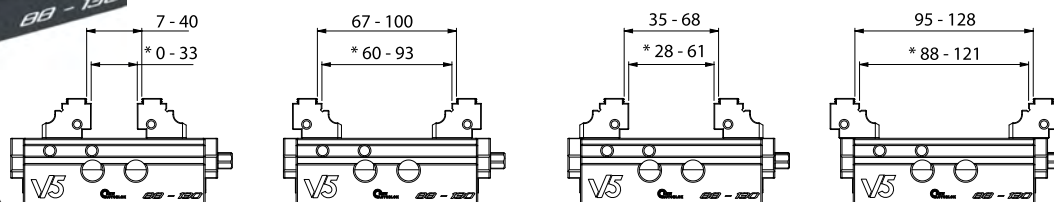

Omschrijving	Artikel	Bruto	Netto
V5 88-130 SinterGrip STD	77583303	€1198,00	€998,00
V5 88-130 SinterGrip HRC	77583304	€1198,00	€998,00
V5 88-130 SinterGrip ALU	77583305	€1198,00	€998,00
V5 88-130 SinterGrip PLM	77583306	€1198,00	€998,00
V5 88-130 Basic uitvoering	77583302	€954,00	€795,00
V5 88-130 exclusief bekken	77583301	€719,00	€599,00

OML V5 125-180 centrumspanner met 125mm bekbreedte

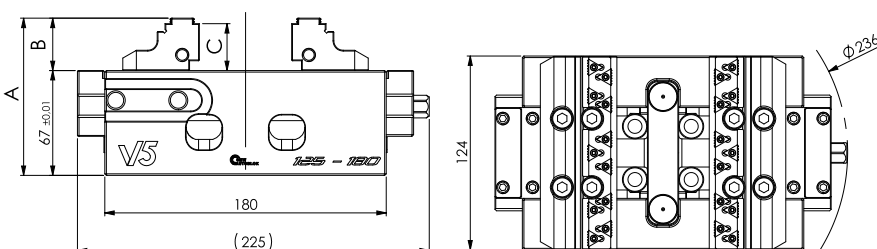

- Altijd zelfcentrerend
- Bekbreedte 125mm
- Spankracht tot 40 kN (80 Nm)
- Boringspatroon voor APS, TDM en Plus5 rasters 52/96mm

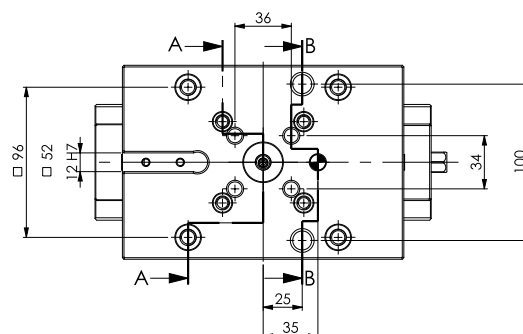
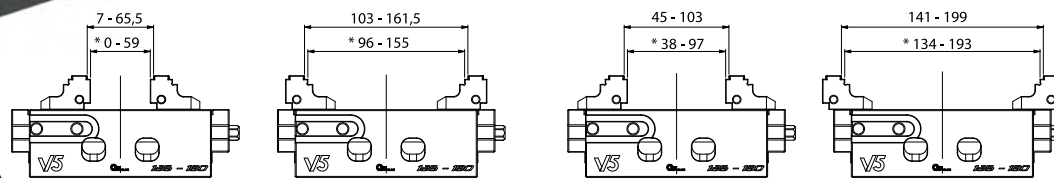

Omschrijving	Artikel	Bruto	Netto
V5 125-180 SinterGrip STD	77583333	€1537,00	€1282,00
V5 125-180 SinterGrip HRC	77583334	€1537,00	€1282,00
V5 125-180 SinterGrip ALU	77583335	€1537,00	€1282,00
V5 125-180 SinterGrip PLM	77583336	€1537,00	€1282,00
V5 125-180 Basic uitvoering	77583332	€1234,00	€1029,00
V5 125-180 exclusief bekken	77583331	€894,00	€745,00

OML Plus5 nulpuntplaat met 52mm raster

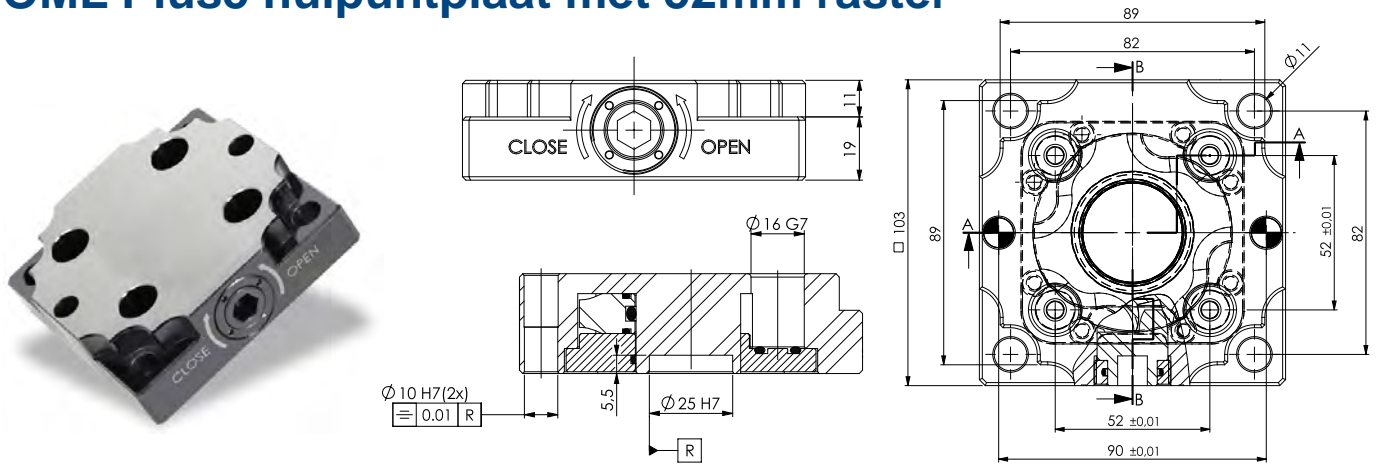

Nulpuntplaat	Artikel	Bruto	Netto
Plus5 nulpuntplaat 103x103mm met 52x52mm raster	46240101	€623,00	€599,00

Spanbout	Artikel	Netto
M8 spanbout H27 voor Plus5 raster 52mm	46240210	€16,70



Spanbouten nodig?

OML Plus5 nulpuntplaat met 52mm én 96mm raster

Nulpuntplaat ALL-IN-ONE	Set artikel
Plus5 ALL-IN-ONE kit 14-delig met 1x nulpuntplaat 46240103 afmetingen 191x191x30mm met 52mm en 96mm raster, incl. 4x spanbout 52mm 46240210, 4x spanbout 96mm 46240220, 4x beschermdop 96mm 46240320 en 1x spansleutel 10mm	46240123
	Actieprijs
	€1259,00



OML Plus5 nulpuntplaat met 96mm raster

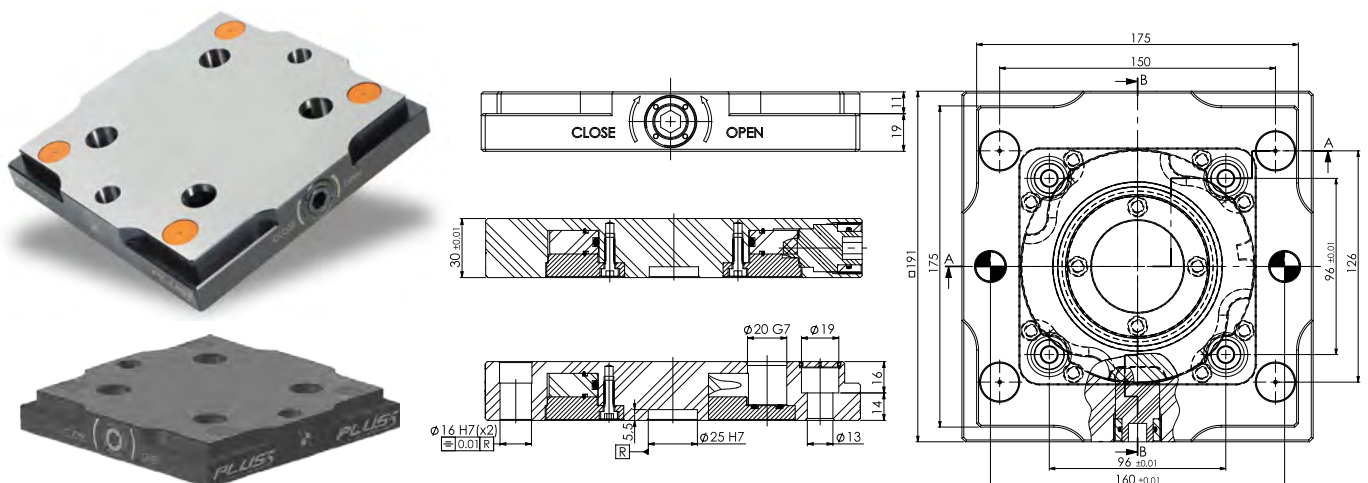

Nulpuntplaat	Artikel	Bruto	Netto
Plus5 nulpuntplaat 191x191mm met 96x96mm raster	46240102	€808,10	€777,00

Spanbout	Artikel	Netto
M10 spanbout H27 voor Plus5 raster 96mm	46240220	€17,70



Spanbout nodig?

Mapal CPM130 QPMill-Uni-HPC-Finish

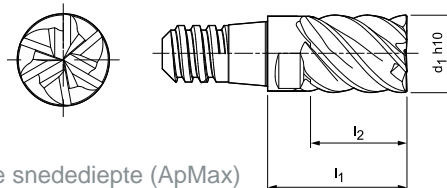
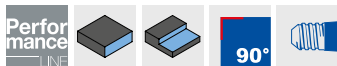

* Maximale snedediepte (ApMax)

D1	CFS	L1	L2	Fase	Z	Ap*	SW	Type aanduiding	Artikel	Bruto	Netto
8	6	15	10,0	-	6	7,5	SW6	CPM130-0800Z06-S-06-HP383	30371380	€ 71,30	€ 55,00
10	8	18	12,5	-	6	9,4	SW8	CPM130-1000Z06-S-08-HP383	30371381	€ 81,20	€ 63,00
12	10	22	15,0	-	6	11,3	SW10	CPM130-1200Z06-S-10-HP383	30371382	€ 100,70	€ 78,00
16	12	28	20,0	-	6	15,0	SW13	CPM130-1600Z06-S-12-HP383	30371383	€ 154,70	€ 119,00
20	16	35	25,0	-	6	18,8	SW16	CPM130-2000Z06-S-16-HP383	30371386	€ 205,50	€ 159,00

Mapal CPM171 QPMill-Uni-FeedPlus

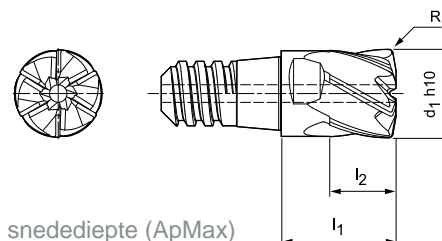

* Maximale snedediepte (ApMax)

D1	CFS	L1	L2	R	Z	Ap*	SW	Type aanduiding	Artikel	Bruto	Netto
8	6	11	6,0	0,4	6	0,4	SW6	CPM171-0800Z06-R0040-06-HP383	30371359	€ 71,30	€ 55,00
10	8	13	7,5	0,5	6	0,5	SW8	CPM171-1000Z06-R0050-08-HP383	30371360	€ 79,70	€ 62,00
12	10	16	9,0	0,6	6	0,6	SW10	CPM171-1200Z06-R0060-10-HP383	30371361	€ 102,00	€ 79,00
16	12	20	12,0	0,8	6	0,8	SW13	CPM171-1600Z06-R0080-12-HP383	30371362	€ 148,00	€ 114,00
20	16	25	15,0	1,0	6	1,0	SW16	CPM171-2000Z06-R0100-16-HP383	30371364	€ 188,00	€ 145,00

Mapal CPM180 QPMill-Chamfer

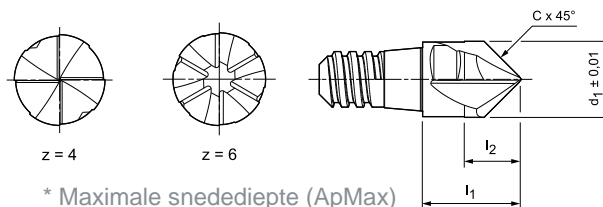
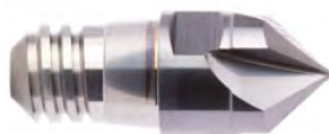

* Maximale snedediepte (ApMax)

D1	CFS	L1	L2	Cx45°	Z	Ap*	SW	Type aanduiding	Artikel	Bruto	Netto
10	8	13	7,5	5,0	4	5,0	SW8	CPM180-1000Z04-F0500-08-HP338	30371353	€ 67,10	€ 52,00
12	10	16	9,0	6,0	4	6,0	SW10	CPM180-1200Z04-F0600-10-HP338	30371354	€ 81,20	€ 63,00
16	12	20	12,0	4,8	6	4,8	SW13	CPM180-1600Z06-F0480-12-HP338	30371355	€ 110,40	€ 85,00
20	16	25	15,0	6,0	6	6,0	SW16	CPM180-2000Z06-F0600-16-HP338	30371357	€ 153,90	€ 119,00

Mapal CFS101 QPMill opname

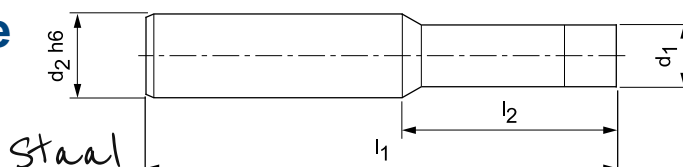

CFS	D1	D2	L1	L2	Type aanduiding	Artikel	Bruto	Netto
6	7,8	10	85	45	CFS101N-06-045-ZYL-HA10-S	30393771	€ 170,40	€ 136,00
8	9,8	12	90	45	CFS101N-08-045-ZYL-HA12-S	30393782	€ 173,90	€ 139,00
10	11,8	16	90	42	CFS101N-10-042-ZYL-HA16-S	30393793	€ 177,50	€ 142,00
12	15,8	16	105	57	CFS101N-12-057-ZYL-HA16-S	30393956	€ 212,20	€ 169,00
16	19,8	25	120	64	CFS101N-16-064-ZYL-HA25-S	30393969	€ 247,10	€ 198,00

Kintek draaibeitels met PSC polygoon opname ISO 26623-1

Een kleine selectie... iets anders nodig? Vraag naar de mogelijkheden!

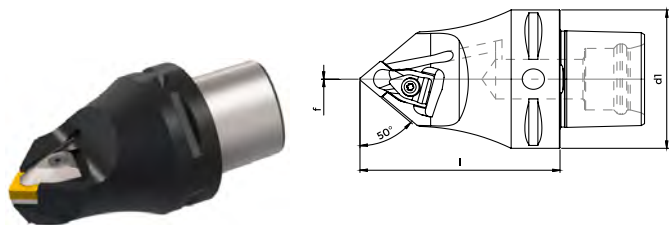

PSC	L	Wisselplaat	Artikel	Bruto	Netto
C63	115	CN..1204..	C63-DCMNN12	€ 385,00	€271,00

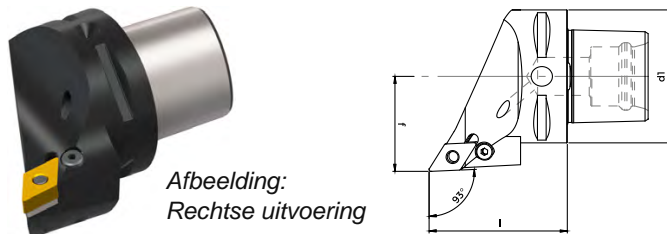

PSC	L	F	Insert	Artikel	Bruto	Netto
C63	65	45	DN..1506	C63-PDJNL15	€ 346,00	€244,00
C63	65	45	DN..1506	C63-PDJNR15	€ 346,00	€244,00

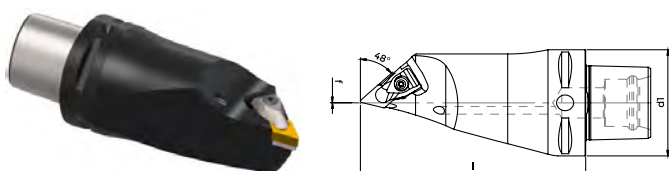

PSC	L	Wisselplaat	Artikel	Bruto	Netto
C63	130	DN..1506..	C63-DDMNL15	€ 346,00	€244,00

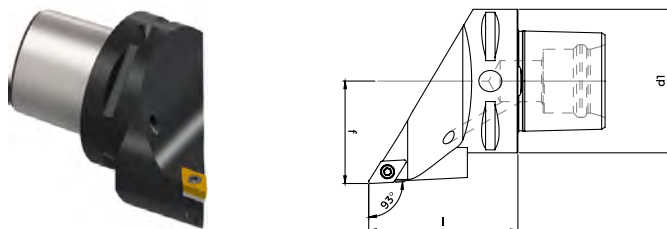

PSC	L	F	Wisselplaat	Artikel	Bruto	Netto
C63	65	45	DC..11T3..	C63-SDJCL11	€ 335,00	€235,00

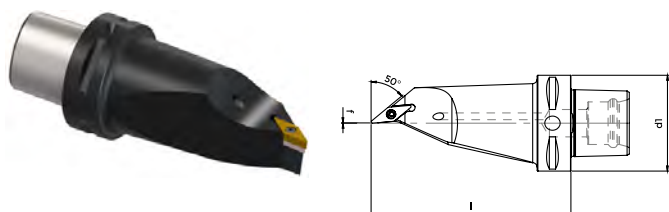

PSC	L	Wisselplaat	Artikel	Bruto	Netto
C63	130	VB..1604..	C63-SVMBL16	€ 341,00	€240,00

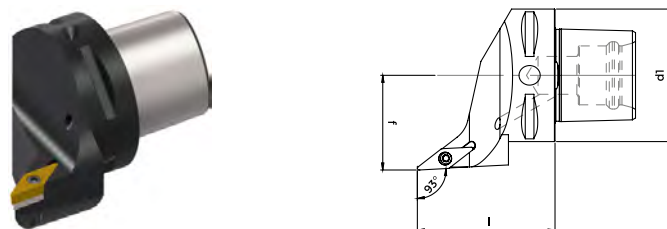

PSC	L	F	Wisselplaat	Artikel	Bruto	Netto
C63	65	45	VB..1604..	C63-SVJBR16	€ 341,00	€240,00

Kintek beitelhouder PSC

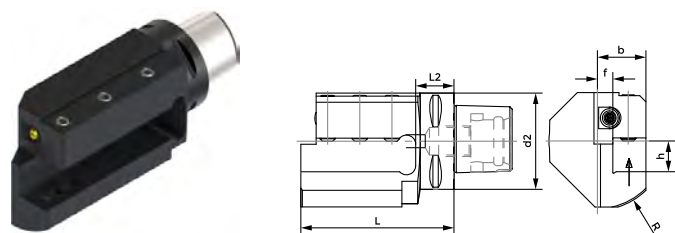

PSC	L	B	H	Artikel	Bruto	Netto
C63	100	32	20	C63-AD2020R/L	€ 373,00	€268,00
C63	130	35	25	C63-AD2525R/L	€ 373,00	€268,00

Kintek steekopname PSC

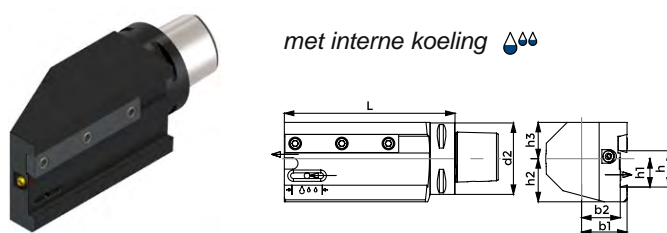

PSC	L	H	Artikel	Bruto	Netto
C63	150	32	C63-SCAR32R/L-IC	€ 478,00	€340,00

Artikelnummer met R/L betreft Rechtse of Linkse uitvoering

Dümmel MiniCut inserts TriCut (3 snijkanten) P04C gecoat

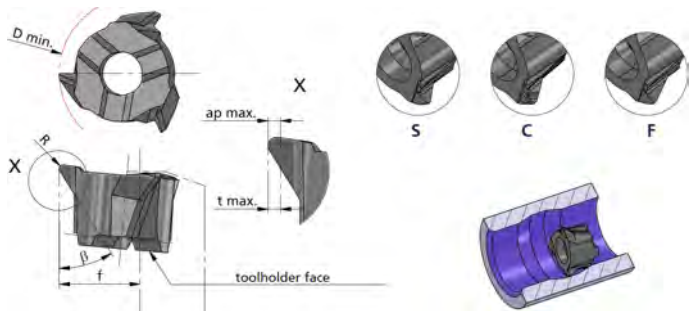

S-type geometrie:

Aanbevolen voor algemene boringsbewerkingen

C-type geometrie:

Met spaanbreker voor optimale spaanvorming

F-type geometrie:

Fijne neusradius voor hoge oppervlaktekwaliteit

f	R	Beta	Ap	Tmax	Dmin	Type	Artikel	Bruto	Netto
4,15	0,1	20°	0,30	0,3	7,8	F	RTC08.2035F01/P04C	€ 22,95	€ 19,70
4,15	0,2	18°	0,25	0,3	7,8	C	RTC08.1835C02/P04C	€ 23,20	€ 19,90
4,15	0,2	18°	0,30	0,3	7,8	S	RTC08.1835S02/P04C	€ 20,20	€ 17,40
4,15	0,2	32°	0,25	0,3	7,8	C	RTC08.3235C02/P04C	€ 23,20	€ 19,90
4,15	0,2	32°	0,30	0,3	7,8	S	RTC08.3235S02/P04C	€ 20,20	€ 17,40
4,15	0,2	47°	0,25	0,3	7,8	C	RTC08.4735C02/P04C	€ 23,20	€ 19,90
4,15	0,2	47°	0,30	0,3	7,8	S	RTC08.4735S02/P04C	€ 20,20	€ 17,40

Dümmel MiniCut TriCut houders STAAL met interne koeling

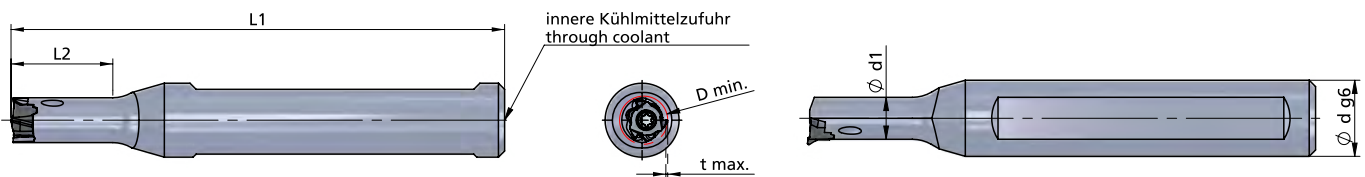

ØD	D1	L1	L2	Koelkanaal	Artikel	Bruto	Netto
12g6	6,6	80	6,6	Rugzijde (blind gat)	TC08.B012.1ST	€ 98,80	€ 79,00
12g6	6,6	80	16,5	Rugzijde (blind gat)	TC08.B012.2ST	€ 110,40	€ 89,00
12g6	6,6	80	6,6	Frontaal (universeel)	TC08.F012.1ST	€ 98,80	€ 79,00
12g6	6,6	80	16,5	Frontaal (universeel)	TC08.F012.2ST	€ 110,40	€ 89,00

Dümmel MiniCut TriCut houders HARDMETAAL met koeling

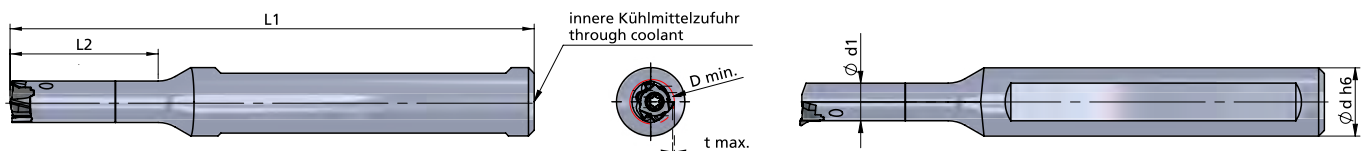

ØD	D1	L1	L2	Koelkanaal	Artikel	Bruto	Netto
12h6	6,6	92	26	Rugzijde (blind gat)	TC08.B012.1HM	€ 172,80	€ 139,00
12h6	6,6	107	39	Rugzijde (blind gat)	TC08.B012.2HM	€ 186,34	€ 149,00
12h6	6,6	117	53	Rugzijde (blind gat)	TC08.B012.3HM	€ 241,95	€ 194,00
12h6	6,6	92	26	Frontaal (universeel)	TC08.F012.1HM	€ 172,80	€ 139,00
12h6	6,6	107	39	Frontaal (universeel)	TC08.F012.2HM	€ 186,34	€ 149,00
12h6	6,6	117	53	Frontaal (universeel)	TC08.F012.3HM	€ 241,95	€ 194,00

Dümmel UltraMini Performance inserts met axiale koeling

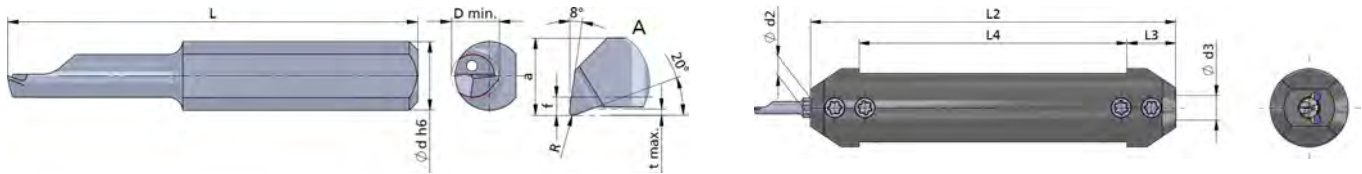

R	f	a	L	L1	Tmax	Dmin	ØD	Artikel	Bruto	Netto
0,05	-0,3	1,7	19	5	0,10	2,0	4h6	RP50.2-5/P04C	€21,95	€17,60
0,05	-0,3	1,7	24	10	0,10	2,0	4h6	RP50.2-10/P04C	€22,45	€18,00
0,05	-0,3	1,7	29	15	0,10	2,0	4h6	RP50.2-15/P04C	€23,75	€19,00
0,10	0,6	2,6	24	10	0,20	2,8	4h6	RP50.3-10/P04C	€21,95	€17,60
0,10	0,6	2,6	30	16	0,20	2,8	4h6	RP50.3-16/P04C	€23,15	€18,60
0,10	0,6	2,6	34	20	0,20	2,8	4h6	RP50.3-20/P04C	€27,75	€22,20
0,10	1,5	3,5	24	10	0,30	4,0	4h6	RP50.4-10/P04C	€21,95	€17,60
0,10	1,5	3,5	30	16	0,30	4,0	4h6	RP50.4-16/P04C	€23,15	€18,60
0,10	1,5	3,5	34	20	0,30	4,0	4h6	RP50.4-20/P04C	€26,40	€21,20
0,10	1,5	3,5	38	24	0,30	4,0	4h6	RP50.4-24/P04C	€29,25	€23,40
0,10	1,5	3,5	42	28	0,30	4,0	4h6	RP50.4-28/P04C	€32,60	€26,10
0,15	1,9	4,4	25	10	0,50	5,0	5h6	RP50.5-10/P04C	€20,70	€16,60
0,15	1,9	4,4	30	15	0,50	5,0	5h6	RP50.5-15/P04C	€22,15	€17,80
0,15	1,9	4,4	35	20	0,50	5,0	5h6	RP50.5-20/P04C	€25,40	€20,40
0,15	1,9	4,4	40	25	0,50	5,0	5h6	RP50.5-25/P04C	€28,90	€23,20
0,15	1,9	4,4	45	30	0,50	5,0	5h6	RP50.5-30/P04C	€32,45	€26,00
0,15	1,9	4,4	50	35	0,50	5,0	5h6	RP50.5-35/P04C	€36,00	€28,80
0,15	1,9	4,4	55	40	0,50	5,0	5h6	RP50.5-40/P04C	€40,20	€32,20
0,15	2,3	5,3	30	15	0,50	6,0	6h6	RP50.6-15/P04C	€22,45	€18,00
0,15	2,3	5,3	37	22	0,50	6,0	6h6	RP50.6-22/P04C	€25,70	€20,60
0,15	2,3	5,3	40	25	0,50	6,0	6h6	RP50.6-25/P04C	€29,25	€23,40
0,15	2,3	5,3	45	30	0,50	6,0	6h6	RP50.6-30/P04C	€32,85	€26,30
0,15	2,3	5,3	50	35	0,50	6,0	6h6	RP50.6-35/P04C	€36,45	€29,20
0,15	2,3	5,3	57	42	0,50	6,0	6h6	RP50.6-42/P04C	€40,70	€32,60
0,15	2,8	6,3	35	20	0,60	6,8	7h6	RP50.7-20/P04C	€27,30	€21,90
0,15	2,8	6,3	40	25	0,60	6,8	7h6	RP50.7-25/P04C	€31,15	€25,00
0,15	2,8	6,3	45	30	0,60	6,8	7h6	RP50.7-30/P04C	€35,15	€28,20
0,15	2,8	6,3	50	35	0,60	6,8	7h6	RP50.7-35/P04C	€39,00	€31,20
0,15	2,8	6,3	55	40	0,60	6,8	7h6	RP50.7-40/P04C	€43,60	€34,90
0,15	2,8	6,3	60	45	0,60	6,8	7h6	RP50.7-45/P04C	€46,10	€36,90
0,15	2,8	6,3	65	50	0,60	6,8	7h6	RP50.7-50/P04C	€49,65	€39,80

Dümmel UltraMini Performance houders met koelkanaal

ØD	L2	L3	L4	Artikel	ØD2	ØD3	Bruto	Netto	Artikel	ØD2	ØD3	Bruto	Netto
12g6	75	10	55	645.PT12-D	4h6	5h6	€97,90	€79,00	-	-	-	-	-
16g6	75	10	55	645.PT16-D	4h6	5h6	€104,10	€84,00	676.PT16-D	6h6	7h6	€104,10	€84,00
18g6	90	10	70	645.PT18-D	4h6	5h6	€110,85	€89,00	676.PT18-D	6h6	7h6	€110,85	€89,00
20g6	90	10	70	645.PT20-D	4h6	5h6	€108,30	€87,00	676.PT20-D	6h6	7h6	€108,30	€87,00
22g6	90	10	70	645.PT22-D	4h6	5h6	€115,25	€93,00	676.PT22-D	6h6	7h6	€115,25	€93,00
25g6	95	10	75	645.PT25-D	4h6	5h6	€115,25	€93,00	676.PT25-D	6h6	7h6	€115,25	€93,00
28g6	95	10	75	645.PT28-D	4h6	5h6	€121,80	€98,00	676.PT28-D	6h6	7h6	€121,80	€98,00

Dümmel MiniMill XL inserts

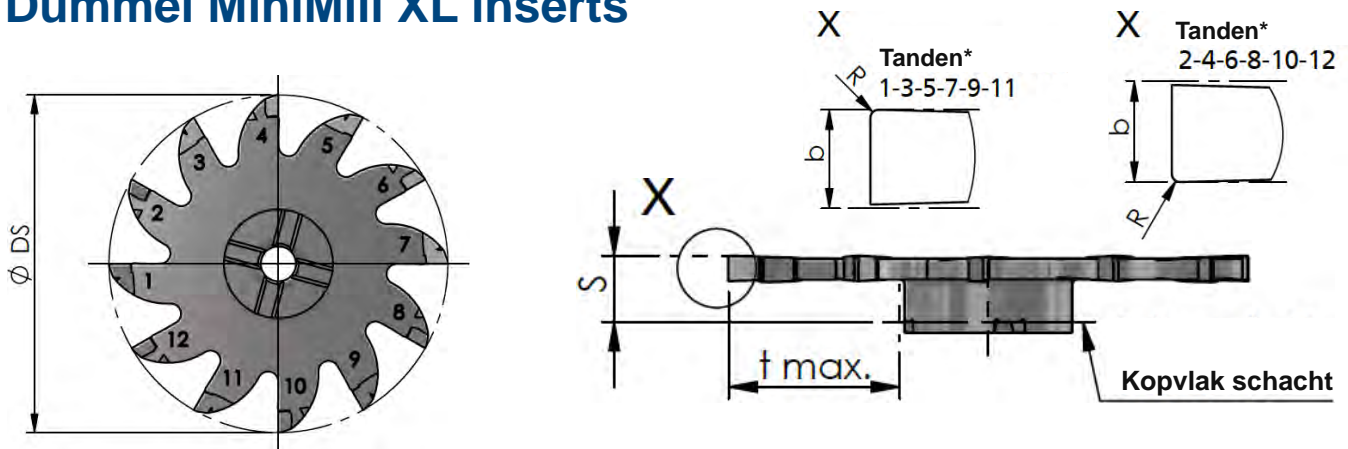

ØS	S	R	B	Tmax	Z	Kruisverand*	Artikel	Bruto	Netto
50	6,35	-	0,50	16,5	12	Nee	X1250.0050.00/P04C	€ 221,70	€ 178,00
50	6,35	-	1,00	16,5	12	Nee	X1250.0100.00/P04C	€ 203,55	€ 163,00
50	6,35	0,1	1,17	16,5	12	✓	X1250.X117.01/P04C	€ 205,45	€ 165,00
50	6,35	0,1	1,50	16,5	12	✓	X1250.X150.01/P04C	€ 182,50	€ 147,00
50	6,35	0,1	1,57	16,5	12	✓	X1250.X157.01/P04C	€ 190,95	€ 153,00
50	6,35	0,2	2,00	16,5	12	✓	X1250.X200.02/P04C	€ 182,50	€ 147,00
50	6,35	0,2	2,38	16,5	12	✓	X1250.X238.02/P04C	€ 184,50	€ 148,00
50	6,35	0,2	2,50	16,5	12	✓	X1250.X250.02/P04C	€ 165,15	€ 133,00
50	6,35	0,2	3,00	16,5	12	✓	X1250.X300.02/P04C	€ 202,25	€ 162,00
50	6,35	0,2	3,17	16,5	12	✓	X1250.X318.02/P04C	€ 222,00	€ 178,00
50	6,35	0,2	3,50	16,5	12	✓	X1250.X350.02/P04C	€ 222,00	€ 178,00

Dümmel MiniMill XL houders *Hét alternatief voor zaagfrezen!*

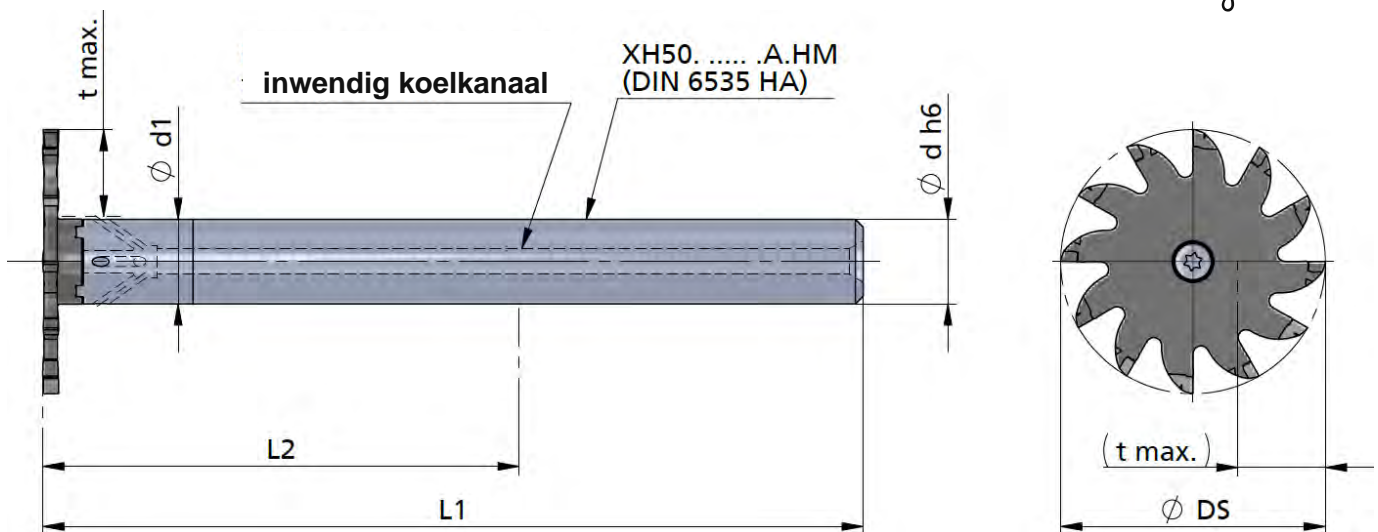

ØD	D1	L1	L2	Materiaal	Artikel	Bruto	Netto
16	16	125	60	Hardmetaal	XH50.1616.060.A.HM	€ 339,15	€ 275,00
16	16	155	90	Hardmetaal	XH50.1616.090.A.HM	€ 363,65	€ 295,00
16	16	185	120	Hardmetaal	XH50.1616.120.A.HM	€ 388,05	€ 315,00
20	16	100	32	Staal	XH50.2016.32.A.ST	€ 164,05	€ 135,00

Dümmel DED inserts seegerring DIN 471/472 gecoat AL41F

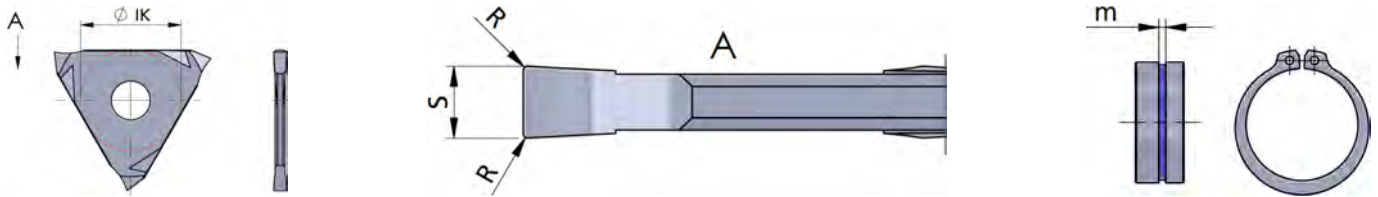

Seegerring	S	R	Ø IK	Opname	SET-DED1	Artikel	Bruto	Netto
0,50	0,57	0,05	13,0	.1-D	✓	DED.0050.00/AL41F	€14,85	€13,85
0,60	0,67	0,05	13,0	.1-D	✓	DED.0060.00/AL41F	€14,85	€13,85
0,70	0,77	0,05	13,0	.1-D	✓	DED.0070.00/AL41F	€14,85	€13,85
0,80	0,87	0,05	13,0	.1-D	✓	DED.0080.00/AL41F	€14,85	€13,85
0,90	0,97	0,05	13,0	.1-D	✓	DED.0090.00/AL41F	€14,85	€13,85
1,00	1,07	0,10	13,0	.1-D	✓	DED.0100.00/AL41F	€14,85	€13,85
1,10	1,24	0,10	13,0	.1-D	✓	DED.0110.00/AL41F	€14,85	€13,85
1,30	1,44	0,10	13,0	.1-D	✓	DED.0130.00/AL41F	€14,85	€13,85
1,60	1,74	0,10	13,2	.1-D	✓	DED.0160.00/AL41F	€14,85	€13,85
1,85	1,99	0,10	13,2	.1-D	✓	DED.0185.00/AL41F	€14,85	€13,85
2,15	2,29	0,10	13,2	.2-D		DED.0215.00/AL41F	€14,85	€13,85
2,65	2,79	0,10	13,2	.2-D		DED.0265.00/AL41F	€14,85	€13,85

Dümmel steekbeitel R/L.207 voor DED inserts

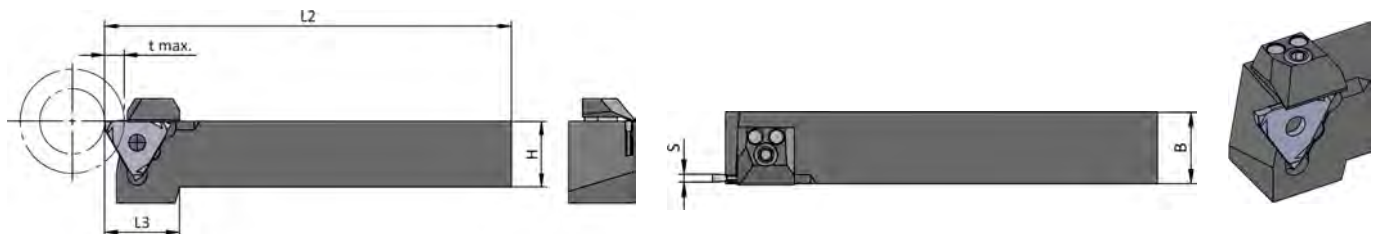

H	B	Tmax	L2	L3	SET-DED1	Artikel	Bruto	Netto
12	12	4	100	28		R.207.1212.1-D	€105,80	€98,00
16	16	4	125	26		R.207.1616.1-D	€94,50	€88,00
20	20	4	125	23	✓	R.207.2020.1-D	€77,65	€72,00
25	25	4	150	-		R.207.2525.1-D	€82,30	€77,00
32	32	4	170	-		R.207.3232.1-D	€95,70	€89,00
12	12	6	100	28		R.207.1212.2-D	€105,80	€98,00
16	16	6	125	26		R.207.1616.2-D	€94,50	€88,00
20	20	6	125	23		R.207.2020.2-D	€77,65	€72,00
25	25	6	150	-		R.207.2525.2-D	€82,30	€77,00
32	32	6	170	-		R.207.3232.2-D	€95,70	€89,00

Type R/L.207 is ook leverbaar met koelmiddeltoevoer: wijzig -D in het artikelnummer naar -IK bijvoorbeeld R.207.2020.1-IK

Dümmel SET-DED1 met 1 beitel en 10 inserts AL41F



Omschrijving	Artikel	Bruto	Netto
Set omvat 1x beitel R.207.2020.1 inclusief 10 DED inserts, één per stuk: DED.0050.00, DED.0060.00, DED.0070.00, DED.0080.00, DED.0090.00 DED.0100.00, DED.0110.00, DED.0130.00, DED.0160.00, DED.0185.00	SET-DED1	€255,75	€199,95

Akko volboren 3xD voor wisselplaten WCM.



Zie pagina 18

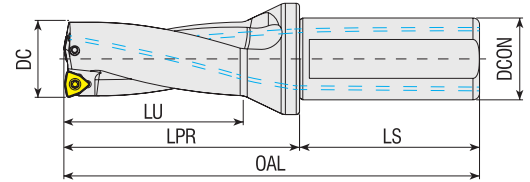

DC	DCON	OAL	LU	LPR	LS	Artikel	Bruto	Netto
16	25	126	48	70	56	ATUM 16XD3 WCM.030208	€ 188,60	€ 136,00
17	25	129	51	73	56	ATUM 17XD3 WCM.030208	€ 188,60	€ 136,00
18	25	132	54	76	56	ATUM 18XD3 WCM.030208	€ 188,60	€ 136,00
19	25	135	57	79	56	ATUM 19XD3 WCM.030208	€ 188,60	€ 136,00
20	25	138	60	82	56	ATUM 20XD3 WCM.040208	€ 196,70	€ 142,00
21	25	141	63	85	56	ATUM 21XD3 WCM.040208	€ 196,70	€ 142,00
22	25	144	66	88	56	ATUM 22XD3 WCM.040208	€ 196,70	€ 142,00
23	25	147	69	91	56	ATUM 23XD3 WCM.040208	€ 196,70	€ 142,00
24	25	150	72	94	56	ATUM 24XD3 WCM.050308	€ 202,00	€ 147,00
25	25	153	75	97	56	ATUM 25XD3 WCM.050308	€ 202,00	€ 147,00
26	25	156	78	100	56	ATUM 26XD3 WCM.050308	€ 202,00	€ 147,00
27	25	159	81	103	56	ATUM 27XD3 WCM.050308	€ 202,00	€ 147,00
28	25	162	84	106	56	ATUM 28XD3 WCM.050308	€ 202,00	€ 147,00
29	25	165	87	109	56	ATUM 29XD3 WCM.050308	€ 202,00	€ 147,00
30	32	177	90	117	60	ATUM 30XD3 WCM.06T308	€ 209,00	€ 151,00
31	32	180	93	120	60	ATUM 31XD3 WCM.06T308	€ 209,00	€ 151,00
32	32	183	96	123	60	ATUM 32XD3 WCM.06T308	€ 209,00	€ 151,00
33	32	186	99	126	60	ATUM 33XD3 WCM.06T308	€ 209,00	€ 151,00
34	32	189	102	129	60	ATUM 34XD3 WCM.06T308	€ 209,00	€ 151,00
35	32	192	105	132	60	ATUM 35XD3 WCM.06T308	€ 209,00	€ 151,00
36	32	195	108	135	60	ATUM 36XD3 WCM.06T308	€ 209,00	€ 151,00
37	32	198	111	138	60	ATUM 37XD3 WCM.06T308	€ 209,00	€ 151,00
38	32	201	114	141	60	ATUM 38XD3 WCM.06T308	€ 209,00	€ 151,00
39	32	204	117	144	60	ATUM 39XD3 WCM.06T308	€ 209,00	€ 151,00
40	32	207	120	147	60	ATUM 40XD3 WCM.06T308	€ 209,00	€ 151,00
43	32	216	129	156	60	ATUM 43XD3 WCM.06T308	€ 230,70	€ 167,00
44	32	219	132	159	60	ATUM 44XD3 WCM.06T308	€ 230,70	€ 167,00
45	40	237	135	167	70	ATUM 45XD3 WCM.080412	€ 239,00	€ 175,00
47	40	243	141	173	70	ATUM 47XD3 WCM.080412	€ 269,60	€ 195,00
49	40	249	147	179	70	ATUM 49XD3 WCM.080412	€ 297,00	€ 215,00
50	40	252	150	182	70	ATUM 50XD3 WCM.080412	€ 323,70	€ 234,00
51	40	255	153	185	70	ATUM 51XD3 WCM.080412	€ 338,00	€ 244,00
52	40	258	156	188	70	ATUM 52XD3 WCM.080412	€ 351,60	€ 254,00
53	40	261	159	191	70	ATUM 53XD3 WCM.080412	€ 359,10	€ 263,00
54	40	264	162	194	70	ATUM 54XD3 WCM.080412	€ 377,80	€ 273,00
55	40	267	165	197	70	ATUM 55XD3 WCM.080412	€ 377,80	€ 273,00
56	40	270	168	200	70	ATUM 56XD3 WCM.080412	€ 377,80	€ 273,00
57	40	273	171	203	70	ATUM 57XD3 WCM.080412	€ 405,70	€ 293,00
58	40	276	174	206	70	ATUM 58XD3 WCM.080412	€ 405,70	€ 293,00
60	40	282	180	212	70	ATUM 60XD3 WCM.080412	€ 405,70	€ 293,00

Akko volboren 3xD voor wisselplaten SP..



Zie pagina 18

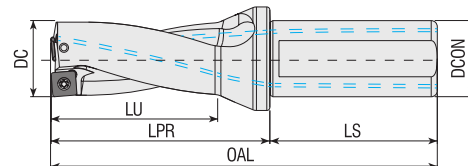
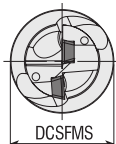

DC	DCON	OAL	LU	LPR	LS	Artikel	Bruto	Netto
13	20	111	39	61	50	ATUM 13XD3 SP..050204	€ 188,60	€ 136,00
14	20	114	42	64	50	ATUM 14XD3 SP..050204	€ 188,60	€ 136,00
15	20	117	45	67	50	ATUM 15XD3 SP..050204	€ 188,60	€ 136,00
16	25	126	48	70	56	ATUM 16XD3 SP..060204	€ 188,60	€ 136,00
17	25	129	51	73	56	ATUM 17XD3 SP..060204	€ 188,60	€ 136,00
18	25	132	54	76	56	ATUM 18XD3 SP..060204	€ 188,60	€ 136,00
19	25	135	57	79	56	ATUM 19XD3 SP..060204	€ 188,60	€ 136,00
20	25	138	60	82	56	ATUM 20XD3 SP..060204	€ 196,70	€ 142,00
21	25	141	63	85	56	ATUM 21XD3 SP..060204	€ 196,70	€ 142,00
22	25	144	66	88	56	ATUM 22XD3 SP..07T308	€ 196,70	€ 142,00
23	25	147	69	91	56	ATUM 23XD3 SP..07T308	€ 196,70	€ 142,00
24	25	150	72	94	56	ATUM 24XD3 SP..07T308	€ 202,00	€ 147,00
25	25	153	75	97	56	ATUM 25XD3 SP..07T308	€ 202,00	€ 147,00
26	25	156	78	100	56	ATUM 26XD3 SP..07T308	€ 202,00	€ 147,00
27	25	159	81	103	56	ATUM 27XD3 SP..07T308	€ 202,00	€ 147,00
28	25	162	84	106	56	ATUM 28XD3 SP..090408	€ 202,00	€ 147,00
29	25	165	87	109	56	ATUM 29XD3 SP..090408	€ 202,00	€ 147,00
30	32	177	90	117	60	ATUM 30XD3 SP..090408	€ 209,00	€ 151,00
31	32	180	93	120	60	ATUM 31XD3 SP..090408	€ 209,00	€ 151,00
32	32	183	96	123	60	ATUM 32XD3 SP..090408	€ 209,00	€ 151,00
33	32	186	99	126	60	ATUM 33XD3 SP..090408	€ 209,00	€ 151,00
34	32	189	102	129	60	ATUM 34XD3 SP..110408	€ 209,00	€ 151,00
35	32	192	105	132	60	ATUM 35XD3 SP..110408	€ 209,00	€ 151,00
36	32	195	108	135	60	ATUM 36XD3 SP..110408	€ 209,00	€ 151,00
37	32	198	111	138	60	ATUM 37XD3 SP..110408	€ 209,00	€ 151,00
38	32	201	114	141	60	ATUM 38XD3 SP..110408	€ 209,00	€ 151,00
39	32	204	117	144	60	ATUM 39XD3 SP..110408	€ 209,00	€ 151,00
40	32	207	120	147	60	ATUM 40XD3 SP..110408	€ 209,00	€ 151,00
41	32	210	123	150	60	ATUM 41XD3 SP..110408	€ 230,70	€ 167,00
42	32	213	126	153	60	ATUM 42XD3 SP..140512	€ 230,70	€ 167,00
43	32	216	129	156	60	ATUM 43XD3 SP..140512	€ 230,70	€ 167,00
44	32	219	132	159	60	ATUM 44XD3 SP..140512	€ 230,70	€ 167,00
45	40	237	135	167	70	ATUM 45XD3 SP..140512	€ 239,00	€ 175,00
46	40	240	138	170	70	ATUM 46XD3 SP..140512	€ 257,30	€ 186,00
47	40	243	141	173	70	ATUM 47XD3 SP..140512	€ 269,60	€ 195,00
48	40	246	144	176	70	ATUM 48XD3 SP..140512	€ 278,00	€ 205,00
49	40	249	147	179	70	ATUM 49XD3 SP..140512	€ 297,00	€ 215,00
50	40	252	150	182	70	ATUM 50XD3 SP..140512	€ 323,70	€ 234,00
51	40	255	153	185	70	ATUM 51XD3 SP..140512	€ 338,00	€ 244,00
52	40	258	156	188	70	ATUM 52XD3 SP..140512	€ 351,60	€ 254,00

Akko volboor inserts WCM.



Universele kwaliteit voor staal, RVS en gietijzer

PVD coating CVD coating

Wisselplaat	Kwaliteit	Netto	Kwaliteit	Netto
WCMX 030208	VG3002	€6,60	LA51	€ 9,30
WCMX 040208	VG3002	€6,60	LA51	€ 9,30
WCMX 050308	VG3002	€6,60	LA51	€ 9,30
WCMX 06T308	VG3002	€7,60	LA51	€10,10
WCMX 080412	VG3002	€8,70	LA51	€10,10

Akko volboor inserts SP..



Universele kwaliteit voor staal, RVS en gietijzer

PVD coating CVD coating

Wisselplaat	Kwaliteit	Netto	Vorm	Kwaliteit	Netto
SPMX 050204	VG3002	€ 7,60	SPKX	LA316	€ 9,30
SPMX 060204	VG3002	€ 7,60	SPKX	LA316	€10,00
SPMX 07T308	VG3002	€ 7,60	SPKX	LA316	€10,00
SPMX 090408	VG3002	€ 9,60	SPKX	LA316	€10,30
SPMX 110408	VG3002	€ 9,60	SPKX	LA316	€10,80
SPMX 140512	VG3002	€11,70	SPKX	LA316	€12,00

LMT Tools MultiFace P45 PRO8 positief vlakfrees systeem

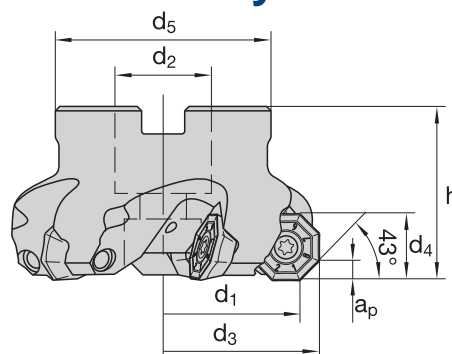
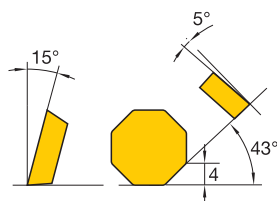

D1	D3	D4	H	D2	D5	Z	Ap	Artikel	Bruto	Netto
50	60	16	40	22	40	4	4	7220260	€ 332,63	€250,00
50	60	16	40	22	40	5	4	7220266	€ 378,30	€290,00
63	73	16	40	22	50	5	4	7220261	€ 385,90	€290,00
63	73	16	40	22	50	6	4	7220267	€ 439,00	€330,00
80	90	16	50	27	60	6	4	7220262	€ 491,70	€370,00
80	90	16	50	27	60	8	4	7220268	€ 594,30	€450,00
100	110	16	50	32	75	7	4	7220263	€ 594,30	€450,00
100	110	16	50	32	75	10	4	7220269	€ 750,50	€570,00
125	135	16	63	40	90	8	4	7220264	€ 643,30	€490,00
125	135	16	63	40	90	12	4	7220270	€ 907,90	€690,00

LMT Tools wisselplaten voor MultiFace P45 PRO8



Wisselplaat	L	D	S	D1	Kwaliteit	Artikel	Netto
OEKT 0605 AESN	6	15,88	5,56	5,5	LCP40M P M	7212188	€15,65
OEKT 0605 AESN	6	15,88	5,56	5,5	LCPK30M P K	7212189	€15,65
OEKT 0605 AESN	6	15,88	5,56	5,5	LCM45M M P	7212190	€19,00
OEKT 0605 AESN	6	15,88	5,56	5,5	LCKP10M P K	7212191	€15,65
OEKT 0605 AEEN-BM	6	15,88	5,56	5,5	LCP40M P M	7212192	€15,65
OEKT 0605 AEEN-BM	6	15,88	5,56	5,5	LCM45M M P	7212193	€19,00
OEKT 0605 AESN-BMS	6	15,88	5,56	5,5	LCP40M P M	7212194	€15,65
OEKT 0605 AESN-BMS	6	15,88	5,56	5,5	LCMS35M M S P	7212195	€19,00

LMT Tools EMZ90 hoekfrees met schroef opname

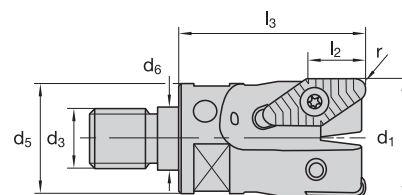
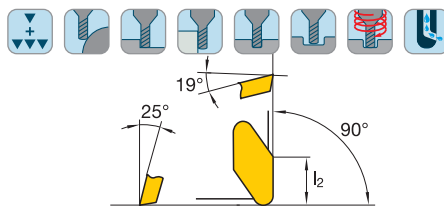

D1	R	L2	L3	D5	D3	D2	Z	Wisselplaat	Artikel	Bruto	Netto
25	1,2	13,5	40	21	M12	12,5	2	VPGT 160412 ALM	1043247	€ 223,40	€ 169,00
32	3,0	15,0	50	29	M16	17,0	2	VCGT 220530 ALM	1043248	€ 236,90	€ 179,00
42	3,0	15,0	50	29	M16	17,0	3	VCGT 220530 ALM	1043249	€ 265,05	€ 199,00

LMT Tools EMZ90 hoekfrees met schacht opname

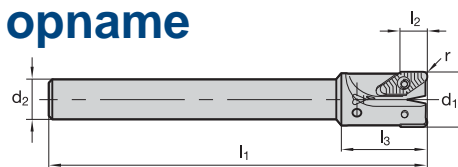

D1	R	L2	L1	L3	D2	Z	Wisselplaat	Artikel	Bruto	Netto
25	1,2	13,5	200	40	20	2	VPGT 160412 ALM	1043243	€ 223,40	€ 169,00
32	3,0	15,0	220	50	25	2	VCGT 220530 ALM	1043244	€ 236,90	€ 179,00

LMT Tools FMZ90 hoekfrees met boring

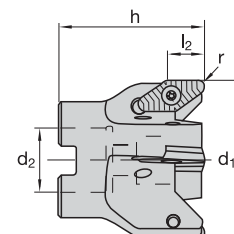
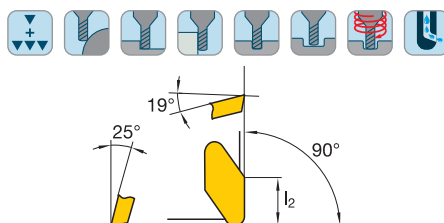

D1	R	L2	H	D2	Z	Wisselplaat	Artikel	Bruto	Netto
42	3	15	55	16	3	VCGT 220530 ALM	1043253	€ 304,24	€ 229,00
52	3	15	55	22	3	VCGT 220530 ALM	1043254	€ 326,10	€ 245,00
66	3	15	60	27	4	VCGT 220530 ALM	1043255	€ 334,40	€ 250,00
80	3	15	60	27	4	VCGT 220530 ALM	1043256	€ 368,40	€ 277,00
100	3	15	65	32	5	VCGT 220530 ALM	1043257	€ 429,62	€ 322,00

LMT Tools wisselplaten voor EMZ90 en FMZ90



Wisselplaat	L	D	S	D1	R	Kwaliteit	Artikel	Netto
VPGT 160412 ALM	16,6	12,7	4,76	4,4	1,2	LWN10M N	1069757	€ 20,05
VPGT 160412 ALM	16,6	12,7	4,76	4,4	1,2	LCN10M N	1069758	€ 21,15
VCGT 220530 ALM	22,1	12,7	5,56	5,5	3,0	LWN10M N	1069759	€ 27,00
VCGT 220530 ALM	22,1	12,7	5,56	5,5	3,0	LCN10M N	1069760	€ 28,25

Tip van de expert: LWN10M kwaliteit (met W van Wolfram) is ongecoat en LCN10M kwaliteit (met C van Coating) is gecoat.

Hagro

Uw partner in efficiënt produceren

137.000+

PRECISIE GEREEDSCHAPPEN

57

JAAR PRAKTIJKERVARING

20

GESPECIALISEERDE
MEDEWERKERS

55

ABSOLUTE TOPMERKEN

ONS LEVERINGSPROGRAMMA



Verspanend Gereedschap

Geschikt voor staal, aluminium, non-ferro, legeringen (hooggelegeerd), kunststof en overige materialen.



Span Gereedschap

"Alles tussen spil en machinebed"
Het spannen van gereedschap en werkstuk is essentieel in uw proces.



Rol Systemen

Met rolkoppen en -machines kan men alle soorten schroefdraad en profielen enorm snel vervaardigen.



Magazijn Inrichting

Hoogwaardig gereedschap verdient het beste opbergsysteem (van Huni) én nauwkeurige meetinstrumenten.

**BENIEUWD NAAR ONZE MOGELIJKHEDEN
NEEM CONTACT OP**



Hagro Precisie BV

+31 486 462424



Industriepark 18
5374 CM Schaijk

+31 486 461650



www.hagro.nl

hagro@hagro.nl

