

bilz

Druckluftgeräte
Universalratschen
Air Pressure Equipment
Universal Ratchets

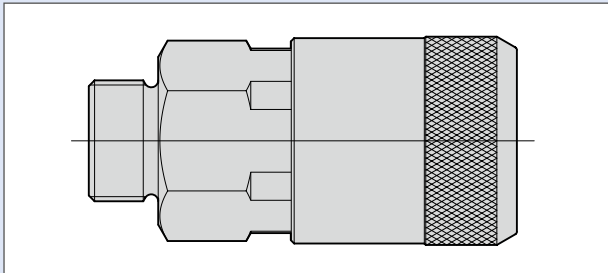

HERMETIKUS – DRUCKLUFT-KUPPLUNGEN zum Ausrüsten von Druckluftanlagen AIR PRESSURE COUPLINGS equipment for air pressure units



Anwendung:

- Anschluss von Rohrleitungen
 - Anschluss von Druckluftwerkzeugen
- Gefahrloses, schnelles Kuppeln und Entkuppeln des Schlauches durch Sicherheitsverschluss

Kuppeln:

Das Ventil öffnet erst, wenn die Tülle in der Kupplung eingerastet ist.

Entkuppeln:

Die Tülle kann erst nach vollständigem Entlüften der Verbindung aus der Kupplung entnommen werden.

Technische Daten:

- Die Sicherheitsversion entspricht dem ISO-Standard 4414
- Geringe Druckverluste durch günstigen Strömungsverlauf
- Drücke bis 50 bar
- Temperaturen bis 80° C, in Sonderausführungen bis 200° C
- In Stahl- und Messingausführungen lieferbar
- Kupplungen Typ HSKE haben einen erweiterten Durchlass und sind speziell zum Anbau an Druckluftwerkzeuge geeignet.
- Kupplungen für Gas und Sauerstoff auf Anfrage

Zubehör:

Schlauchtüllen für Schlauchbefestigung, Anschraubtüllen mit Außen- und Innengewinde für Druckluftgeräte und Vorrichtungen, Aufschraubtüllen für Kupplungen

Hermetik-Druckluft-Hahnen und -Pistolen

Ergonomische Form, geringes Gewicht für einfache Bedienbarkeit, gut regulierbarer Luftdurchlass

Zubehör:

Verlängerungsdüsen, Schutzdüsen und Lärmschutzdüsen können an Stelle der normalen Blasdüse auf die Hahnen und Pistolen aufgeschraubt werden. Zusätzlich können Schutzschilde als Spritzschutz verwendet werden.

Application:

- Connection of tubes
 - Connection of air pressure tools
- Safe and quick coupling and decoupling of the hose by a safety lock

Coupling:

The valve only opens if the socket of the coupling is locked in place.

Decoupling:

The socket can only be taken out of the coupling after the connection had been completely deaerated.

Technical data:

- The safety version is according ISO-standard 4414
- Marginal pressure losses due to a favourable air flow
- Pressures up to 50 bar
- Temperatures up to 80° C, in special designs up to 200° C
- Available in steel and brass design
- The couplings type HSKE have an enlarged flow diameter and are particularly suitable for mounting of air pressure tools.
- Couplings for gas and oxygen on request

Accessories:

Hose sockets for hose connection, connecting sockets with external and internal thread for air pressure units and fixtures, connecting sockets for couplings

Hermetik Air Pressure Valves and Air Pressure Guns

Ergonomic design, low weight for easy handling
easily adjustable air flow

Accessories:

Extended nozzles, protection nozzles and noise protection nozzles can be screwed on the valves and guns instead of the normal blast nozzle. Additional protection shields can be used as splash guards.

Sicherheits-Kupplungen Typ HSK
Safety Couplings Type HSK

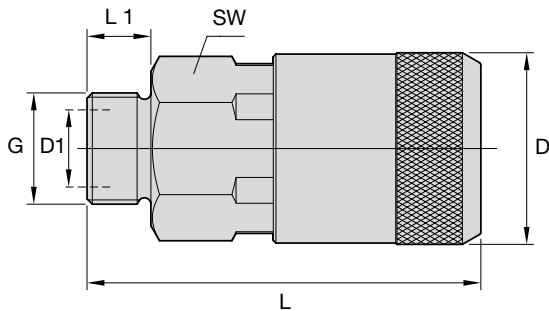

Bezeichnung Designation	Anschlussgewinde Thread G	Id. Nr. Id. No.	Durchgang Passage D1 Ø	D Ø	SW	L	L1
HSK0	G1/4"	6706634	4,0	28	24	61	8
	G3/8"	6706638			10	63	10
HSK1	G3/8"	6706647	7,5	36	30	72	10
	G1/2"	6706652				74	12
	G3/4"	6706661				77	15
HSK2	G1/2"	6706664	10,0	44	36	82	12
	G3/4"	6706669				85	15
HSK3	G3/4"	6706680	15,0	49	41	98	15
	G1"	6706686				102	20

Bestellbeispiel Example for ordering
 HSK1 / G 3/8"

Auch in Messing lieferbar
 Also available in brass

Schlauchtüllen Typ K-T, zum Befestigen des Schlauches
Hose Sockets Type K-T, to connect the hose

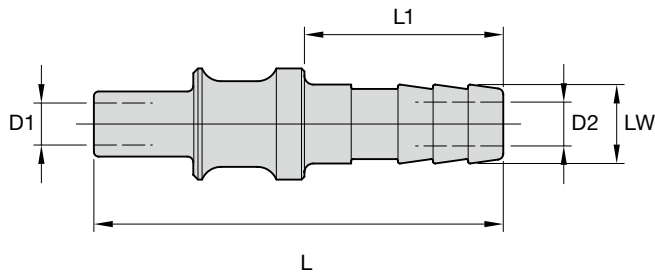

Bezeichnung Designation	LW	Id. Nr. Id. No.	passend in Kupplungen suitable for couplings HSK	Durchgang Passage D1 Ø	D2 Ø	L	L1
K-T0	6	6706774	0	4,0	4,0	60	28
	10	6706777					
K-T1	10	6706787	1	7,5	7,5	70	34
	13	6706788					
K-T2	10	6706802	2	10,0	7,5	81	37
	13	6706803			10,0		
	16	6706804					
	19	6706805					
K-T3	13	6706823	3	15,0	10,0	89	41
	16	6706824			12,5		
	19	6706825			15,0		
	25	6706827					

Bestellbeispiel Example for ordering
 K-T1 LW 10

Auch in Messing lieferbar
 Also available in brass

Außen-Gewindetüllen Typ K-GT-A..., zum Einschrauben in Druckluftwerkzeuge und Vorrichtungen
Sockets Type K-GT-A..., with external thread to be screwed in air pressure tools and units

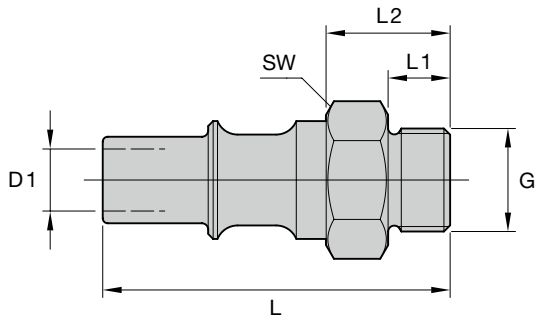

Bezeichnung Designation	G	Id. Nr. Id. No.	passend in Kupplungen suitable for couplings HSK	Durchgang Passage D1 Ø	SW	L	L1	L2
K-GT0-A	G1/4"	6706837	0	4,0	17	47,5	8	16
	G3/8"	6706840				49,5	10	18
K-GT1-A	G1/4"	6706850	1	7,5	22	54,0	8	18
	G3/8"	6706845				56,0	10	20
	G1/2"	6706848				58,0	12	22
K-GT2-A	G3/8"	6706856	2	10,0	24	64,0	10	20
	G1/2"	6706852			24	66,0	12	22
	G3/4"	6706854			27	69,0	15	25
K-GT3-A	G3/4"	6706859	3	15,0	32	74,5	15	27
	G1"	6706862			36	79,5	20	32

Bestellbeispiel Example for ordering
K-GT1-AG 1/2"

Auch in Messing lieferbar
Also available in brass

Innen-Gewindetüllen Typ K-GT-I..., zum Einschrauben in Druckluftwerkzeuge und Vorrichtungen
Sockets Type K-GT-I..., with internal thread to be screwed in air pressure tools and units

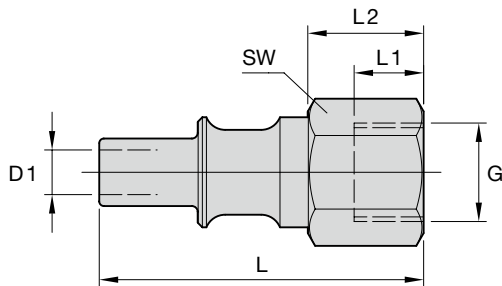

Bezeichnung Designation	G	Id. Nr. Id. No.	passend in Kupplungen suitable for couplings HSK	Durchgang Passage D1 Ø	SW	L	L1	L2			
K-GT0-I	G1/4"	6706871	0	4,0	17	51,5	12	20,0			
	G3/8"	6706873			22						
K-GT1-I	G1/4"	6706882	1	7,5	22	56,0	12	20,0			
	G3/8"	6706877			24				61,0	15	25,0
	G1/2"	6706880									
K-GT2-I	G3/8"	6706889	2	10,0	24	66,0	12	22,0			
	G1/2"	6706885			32	69,0	15	25,0			
	G3/4"	6706887									
K-GT3-I	G3/4"	6706893	3	15,0	32	73,0	15	25,5			
	G1"	6706896			41			77,0	29,5		

Bestellbeispiel Example for ordering
K-GT1-IG 1/2"

Auch in Messing lieferbar
Also available in brass

Sicherheits-Kupplungen Typ HSKE
Safety Couplings Type HSKE

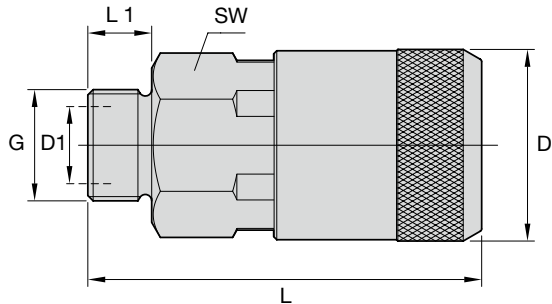

Bezeichnung Designation	Anschlussgewinde Thread G	Id. Nr. Id. No.	Durchgang Passage D1 Ø	D Ø	SW	L	L1
HSKE00	G 1/8"	6706708	4,5	20	14	48	8
	G 1/4"	6706710			17		
HSKE0	G 1/4"	6706713	7,5	28	24	61	8
	G 3/8"	6706717				63	
HSKE1	G 3/8"	6706728	10,0	36	30	72	10
	G 1/2"	6706730				74	
HSKE2	G 1/2"	6706733	12,5	44	36	82	12
	G 3/4"	6706735				85	

Bestellbeispiel Example for ordering
 HSK1 / G 3/8"

Auch in Messing lieferbar
 Also available in brass

Schlauchtüllen Typ KE-T, zum Befestigen des Schlauches
Hose Sockets Type KE-T, to connect the hose

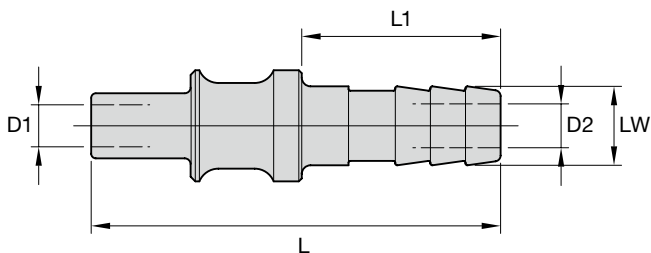

Bezeichnung Designation	LW	Id. Nr. Id. No.	passend in Kupplungen suitable for couplings HSKE	Durchgang Passage D1 Ø	D2 Ø	L	L1
KE-T00	6	6706900	00	4,5	4,5	51	26
	10	6706902			7,5		
KE-T0	10	6706908	0	7,5	7,5	60	28
	13	6706909					
KE-T1	10	6706916	1	10,0	10,0	70	34
	13	6706917			12,0		
	16	6706918			13,0		
KE-T2	13	6706923	2	12,5	10,0	81	37
	16	6706924			12,5		
	19	6706925			15,0		

Bestellbeispiel Example for ordering
 KE-T1/LW 13

Auch in Messing lieferbar
 Also available in brass

Außen-Gewindetüllen Typ KE-GT-A..., zum Einschrauben in Druckluftwerkzeuge und Vorrichtungen
Sockets Type KE-GT-A..., with external thread to be screwed in air pressure tools and units

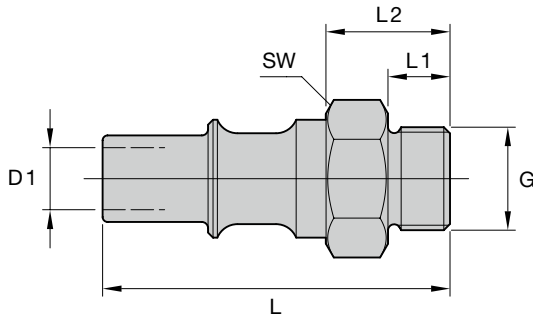

Bezeichnung Designation	G	Id. Nr. Id. No.	passend in Kupplungen suitable for couplings HSKE	Durchgang Passage D1 Ø	SW	L	L1	L2
KE-GT00-A	G 1/8"	6706929	00	4,5	14	38,0	8	15
	G 1/4"	6706931			17			
KE-GT0-A	G 1/8"	6706940	0	5,0	17	47,5	8	16
	G 1/4"	6706933		7,5				
	G 3/8"	6706935		49,5		10	18	
KE-GT1-A	G 3/8"	6706941	1	10,0	22	56,0	10	20
	G 1/2"	6706943				58,0	12	22
KE-GT2-A	G 3/8"	6706949	2	10,0	24	64,0	10	20
	G 1/2"	6706946		12,5		66,0	12	22
	G 3/4"	6706947		27		69,0	15	25

Bestellbeispiel Example for ordering
KE-GT1-AG 1/2"

Auch in Messing lieferbar
Also available in brass

Innen-Gewindetüllen Typ KE-GT-I..., zum Einschrauben in Druckluftwerkzeuge und Vorrichtungen
Sockets Type KE-GT-I..., with internal thread to be screwed in air pressure tools and units

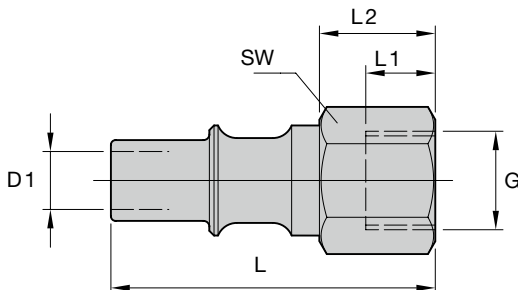

Bezeichnung Designation	G	Id. Nr. Id. No.	passend in Kupplungen suitable for couplings HSKE	Durchgang Passage D1 Ø	SW	L	L1	L2
KE-GT00-I	G 1/8"	6706950	00	4,5	14	42,0	12	19
	G 1/4"	6706952			17			
KE-GT0-I	G 1/4"	6706954	0	7,5	17	51,5	12	20
	G 3/8"	6706956			22			
KE-GT1-I	G 3/8"	6706959	1	10,0	22	56,0	12	20
	G 1/2"	6706961			24			
KE-GT2-I	G 1/2"	6706963	2	12,5	24	69,0	15	25
	G 3/4"	6706965			32			

Bestellbeispiel Example for ordering
KE-GT1-IG 1/2"

Auch in Messing lieferbar
Also available in brass

Aufschraubtüllen Typ K-AT, zum Aufschrauben auf alle Kupplungen
Thread Sockets Type K-AT, for screwing onto all couplings

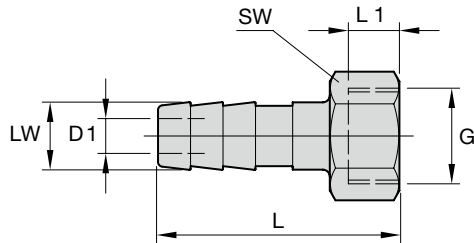

Bezeichnung Designation	LW	Id. Nr. Id. No.	passend in Kupplungen suitable for couplings HSK	Durchgang Passage D1 Ø	SW	L	L1
K-AT-G1/4"	6	6706971	0	4,5	17	37	6
	10	6706973		6,0			
K-AT-G3/8"	6	6706978	0 + 1	4,0	19	46	8
	8	6706980		5,5			
	10	6706981		7,5			
	13	6706982		10,0			
K-AT-G1/2"	10	6706991	1 + 2	7,5	24	52	11
	13	6706992		10,0			
	16	6706993		12,5			
K-AT-G3/4"	13	6707002	2 + 3	10,0	30	59	14
	16	6707003		12,5			
	19	6707004		15,0			
K-AT-G1"	19	6707013	3	15,0	41	66	19
	25	6707014		18,5		75	

Bestellbeispiel Example for ordering
K-AT-G 3/8" / LW10

Auch in Messing lieferbar
Also available in brass

Hermetikus-Drucklufthahnen Typ HH
 Hermetikus Air Pressure Valves Type HH

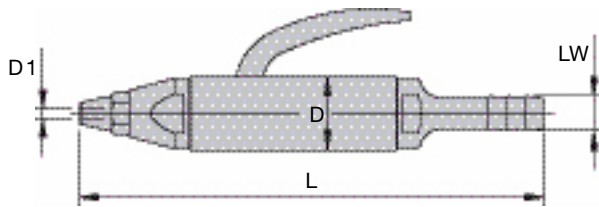

Bezeichnung Designation	LW	Id. Nr. Id. No.	passende Zubehörteile (Seite 10+11) Accessories (page 10+11)				Blasdüse Blast Nozzle		
			Schutzschild Protection Shield	Schutzdüse Protection Nozzle	Lärmschutzdüse Noise Protection Nozzle	Verlängerungsdüse Extended Nozzle	D1	D	L2
HH0	6	6707035	HS 0	HSD 01	HLD 0	HV 0	2	18	123
	8	6707036							
	10	6707038							
HH1	10	6707049	HS 1	HSD 10	HLD 1	HV 1	3	24	152
	13	6707050							
HH2	13	6707072	-	HSD 2	HLD 2	-	5	28	159
	16	6707073							
HH3	13	6707096	-	-	HLD 3	-	10	36	195
	16	6707097							
	19	6707099							

Bestellbeispiel Example for ordering
 HH1/LW10

Hermetikus-Druckluftpistolen Typ HP
 Hermetikus Air Pressure Guns Type HP

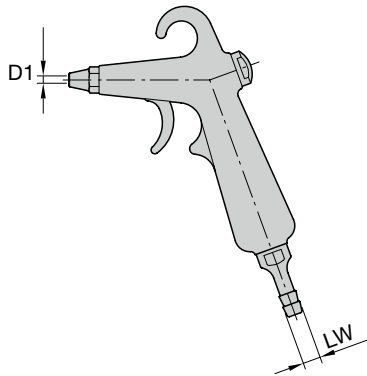

Bezeichnung Designation	LW	Id. Nr. Id. No.	passende Zubehörteile (Seite 10+11) Accessories (page 10+11)				Blasdüse Blast Nozzle
			Schutzschild Protection Shield	Schutzdüse Protection Nozzle	Lärmschutzdüse Noise Protection Nozzle	Verlängerungsdüse Extended Nozzle	D1
HP1	6	6707142	HS 1	HSD 10	HLD 1	HV 1	2
	10	6707145					
	13	6707146					

Bestellbeispiel Example for ordering
 HP1/LW 10

Schutzschilde Typ HS, gegen Späne, erhältlich in Kunststoff und Stahl
Protection Shields Type HS, against chips, available in plastic and steel

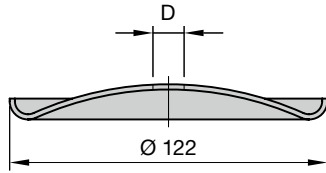

Bezeichnung Designation	Id. Nr. Id. No.	passend für suitable for		D Ø
		Hahnen Valves	Pistolen Guns	
HS0-K	6707175	HH 0	-	8
HS1-K	6707177	HH 1	HP 1	10

Bestellbeispiel Example for ordering
HS1-K

Schutzdüsen Typ HSD, gegen Späne
Protection Nozzles Type HSD, against chips

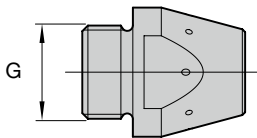

Bezeichnung Designation	Id. Nr. Id. No.	passend für suitable for		G
		Hahnen Valves	Pistolen Guns	
HSD01-AL	6707020	HH 0	-	M 8 x 1,0
HSD10-AL	6707021	HH 1	HP 1	M 10 x 1,0
HSD2-AL	6707018	HH 2	-	M 24 x 1,5

Bestellbeispiel Example for ordering
HSD10-AL

Lärmschutzdüsen Typ HLD
Noise Protection Nozzles Type HLD

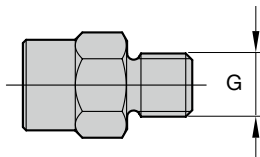

Bezeichnung Designation	Id. Nr. Id. No.	passend für suitable for		G Ø
		Hahnen Valves	Pistolen Guns	
HLD0	6707025	HH0	–	M 8 x 1,0
HLD1	6707026	HH1	HP 1	M 10 x 1,0
HLD2	6707027	HH2	–	M 24 x 1,5
HLD3	6707028	HH3	–	M 30 x 1,5

Bestellbeispiel Example for ordering
HLD1

Verlängerungsdüsen Typ HV in gerader oder gebogener Ausführung
Extended nozzles Type HV straight or curved

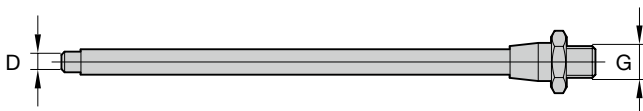

Bezeichnung Designation	Id. Nr. Id. No.	passend für suitable for		Düsen Nozzle D Ø	G Ø	gestreckte Länge ohne Gewinde Length without Thread (straight)
		Hahnen Valves	Pistolen Guns			
HV0	6707166	HH0	–	2	M 8 x 1,0	160
HV1	6707168	HH1	HP1	3	M 10 x 1,0	185

Bestellbeispiel Example for ordering
HV1 gerade oder gebogen straight or curve



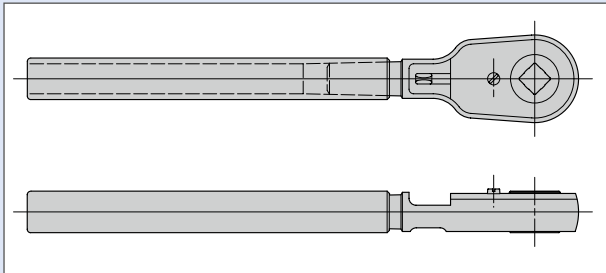

Anwendung:

Für Reparatur- und Montagearbeiten sowie zum Anbau an Maschinen und Geräten.

Merkmale:

Stabile Konstruktion und einfache Handhabung
Ratschengehäuse brüniert, Verschleißteile gehärtet.
Die Einsätze können leicht ausgewechselt werden und sind einzeln oder satzweise lieferbar.

Standardausführung:

Typ R umschaltbar für Rechts- und Linksgang.
Einsätze bei Mittelstellung des Schalthebels gesperrt.

Sonderausführungen:

Mit verlängertem Hebelarm
Mit Hebelarm nach Kundenzeichnung (z.B. gekröpft)
Verstärkte Ausführung für höhere Drehmomente
Verchromte oder bichromatisierte Ausführung
Sonderprofile in den Einsätzen

Typ RGS Vorteile:

- robuste Ausführung durch Verwendung von gehärteten Bauteilen
- formschlüssige Arretierung der gewählten Schaltrichtung, (Links-Rechts-Neutral) dadurch keine unkontrollierte Verstellung der Schaltrichtung möglich
- kompakte Bauweise durch in den Schaltgriff integrierten Umschaltmechanismus
- ergonomisches Design

Application:

For repairs and assembly work as well as for installation in machines and units.

Features:

Solid construction and easy handling
Ratchet housing burnished, wear parts hardened
The adaptors are easy to change and are available individually or in sets.

Standard Design:

Type R adjustable for left and right handed operation
Adaptors are blocked in centre position of the lever

Special Designs:

With extended lever
With lever according to customer drawing (e.g. pipe)
Reinforced design for higher torques
Chrome plated or bi-chromated design
Special profiles in the inserts

Type RGS Advantages:

- robust design due to hardened components
- positive locking of the chosen direction (left-right-neutral), therefore no unintentional change of direction possible
- compact design due to the adjusting mechanism integrated in the lever
- ergonomic design

Universal-Ratschen Typ R, umschaltbar für Rechts- und Linksgang mit Schalthebel
Universal Ratchets Type R, adjustable for right and left handed operation with lever

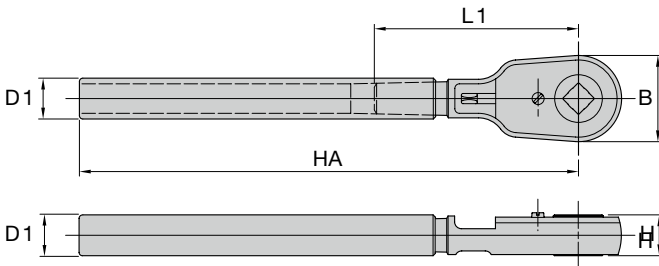

Bezeichnung Designation	rechts- und links- wirkend left and right handed operation	Baumaße Dimensions					Mt max Nm	passende Einsätze suitable inserts			
		Id. Nr. Id. No.	HA	B	H	D1		L1	Vierkant square	Sechskant hexagon	Bohrung mit Keilnut nach Bore hole with keyway acc. DIN 6885 Bl.1
									SW	SW	D
R00-HA115	6705146	115	20,5	8	12	64	40	2,1 – 8,0	3 – 9	–	
R0-HA155	6705154	155	29,0	11	15	81	100	3,4 – 11,0	5 – 12	10	
R1-HA175	6705166	175	37,0	17	18	90	130	4,9 – 14,5	8 – 16	15 – 16	
R2-HA220	6705181	220	45,0	22	20	110	180	10,0 – 18,0	14 – 21	16 – 18	
R3-HA300	6705202	300	56,0	28	25	143	400	14,0 – 22,0	16 – 27	20 – 24	
R4-HA380	6705235	380	70,0	34	28	165	500	18,0 – 30,0	24 – 36	25 – 30	
R5-HA550	6705273	550	100,0	38	32	226	800	25,0 – 46,0	27 – 50	30 – 45	
R6-HA750	6705304	750	127,0	43	35	269	1000	40,0 – 60,0	46 – 70	40 – 65	
R7-HA1100	6705332	1100	173,0	50	40	320	1400	50,0 – 80,0	60 – 90	70 – 85	
R8-HA1300	6705355	1300	225,0	70	40	340	1400	70,0 – 115,0	80 – 130	90 – 120	
R9-HA1500	6705366	1500	280,0	95	46	397	2000	90,0 – 155,0	100 – 175	140 – 160	

Weitere Hebelarmlängen auf Anfrage Additional lever lengths available on request

Bestellbeispiel Example for ordering

Ratsche ohne Einsatz: Bilz-Ratsche R4-HA380 Ratchet without insert: Bilz Ratchet R4-HA380

passende Ratscheneinsätze s. Seite 17 – 20

suitable ratchet inserts see Page 17 – 20

Universal-Ratschen Typ RGS/RG
Universal Ratchets Type RGS/RG

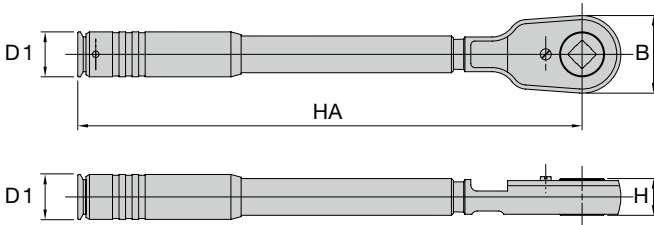

Bezeichnung Designation	Id. Nr. Id. No.	Baumaße Dimensions				Mt max Nm	passende Einsätze suitable inserts		
		HA	B	H	D1		Vierkant square SW	Sechskant hexagon SW	Bohrung mit Keilnut nach Bore hole with keyway acc. DIN 6885 Bl.1 D
RGS0-HA165	9069106	165	29	11	19	100	3,4 – 11,0	5 – 12	10
RGS1-HA200	9096104	200	37	17	23	130	4,9 – 14,5	8 – 16	15 – 16
RGS2-HA240	9096047	240	45	22	28	180	10,0 – 18,0	14 – 21	16 – 18
RGS3-HA300	9096046	300	56	28	32	400	14,0 – 22,0	16 – 27	20 – 24
RGS4-HA380	6706077	380	70	34	36	500	18,0 – 30,0	24 – 36	25 – 30

Die Universal-Ratschen Typ RGS umschaltbar für Rechts- und Linksgang mit Schaltgriff am Hebelende und formschlüssiger Arretierung der gewählten Schaltrichtung (RG ohne); dadurch ist keine unkontrollierte Verstellung möglich.
 Das ergonomische Design bietet eine optimale Handhabung.
 Die robuste Ausführung wird durch die Verwendung von gehärteten Bauteilen erreicht.

Universal ratchets Type RGS, adjustable for left and right handed operation, with handle at the end of the lever and with positive locking of the selected direction (RG without); therefore no unintentional adjustment possible.
 The ergonomic design offers optimal handling. Hardened components make the ratchets robust.

Bestellbeispiel Example for ordering

Ratsche ohne Einsatz: Bilz-Ratsche RGS2 Ratchet without adaptor: Bilz Ratchet RGS2

passende Ratscheneinsätze s. Seite 17 – 20
 suitable ratchet inserts see Page 17 – 20

Bezeichnung Designation	Id. Nr. Id. No.	Baumaße Dimensions					Mt max Nm	passende Einsätze suitable inserts		
		HA	B	H	D1	L1		Vierkant square SW	Sechskant hexagon SW	Bohrung mit Keilnut nach Bore hole with keyway acc. DIN 6885 Bl.1 D
RG00-HA115	6705369	115	20,5	8	12	64	40	2,1 – 8,0	3 – 9	–
RG0-HA155	6705370	155	29,0	11	15	81	100	3,4 – 11,0	5 – 12	10
RG1-HA175	6705372	175	37,0	17	18	90	130	4,9 – 14,5	8 – 16	15 – 16
RG2-HA220	6705375	220	45,0	22	20	110	180	10,0 – 18,0	14 – 21	16 – 18
RG3-HA300	6705378	300	56,0	28	25	143	400	14,0 – 22,0	16 – 27	20 – 24
RG4-HA380	6705385	380	70,0	34	28	165	500	18,0 – 30,0	24 – 36	25 – 30
RG5-HA550	6705391	550	100,0	38	32	226	800	25,0 – 46,0	27 – 50	30 – 45
RG6-HA750	6705399	750	127,0	43	35	269	1000	40,0 – 60,0	46 – 70	40 – 65
RG7-HA1100	6705401	1100	173,0	50	40	320	1400	50,0 – 80,0	60 – 90	70 – 85
RG8-HA1300	–	1300	225,0	70	40	340	1400	70,0 – 115,0	80 – 130	90 – 120
RG9-HA1500	6705402	1500	280,0	95	46	397	2000	90,0 – 155,0	100 – 175	140 – 160

Weitere Hebelarmlängen auf Anfrage Additional lever lengths available on request

Bestellbeispiel Example for ordering

Ratsche ohne Einsatz: Bilz-Ratsche RG4 Ratchet without insert: Bilz Ratchet RG4

passende Ratscheneinsätze s. Seite 17 – 20
 suitable ratchet inserts see Page 17 – 20

Universal-Ratschen Typ RS
Universal Ratchets Type RS



Der Bilz Universal-Ratschensatz mit Vierkanteinsätzen ist z.B. an schwer zugänglichen Stellen zum Gewindeschneiden und Reiben in der Montage und bei Reparaturarbeiten geeignet.

Die Box enthält 1 Bilz Universal-Ratsche Typ R, einen Satz Vierkanteinsätze und 1 Schraubendreher. Aussparungen für weitere Ratscheneinsätze sind vorgesehen.

In badly accessible places, the Bilz set of Universal Ratchets with square inserts is suitable for threading and reaming in the assembly department and for repair work. The box contains 1 Bilz Universal Ratchet type R, a set of square inserts and 1 screw driver. Space for further ratchet adaptors is provided.

Bezeichnung Designation	Ratsche Ratchet	Id. Nr. Id. No.	Inhalt der Box Contents of the box									Außenmaße in mm External Dimensions in mm				
			Vierkant-Einsätze Square Inserts									L	B W	H		
			2,1	2,7	3	3,4	4,9	5,5	6,2	7	8					
RS00/DIN	R00	6705148	2,1	2,7	3	3,4	4,9	5,5	6,2	7	8	170	x	80	x	30
RS0/DIN	R0	6705156	3,4	4,9	5,5	6,2	7	8	9	11		220	x	110	x	36

Bestellbeispiel Example for ordering

Bilz-Ratschensatz RS0/DIN Ratchet Inserts RS0/DIN

Ratschensatz mit anderen Vierkant-Einsätzen auf Anfrage Ratchet set with other square inserts on request

Ratschen-Einsatz: Vierkant = VKT
Ratchet Inserts: square = VKT

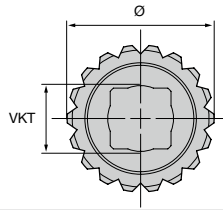

VKT...	Bezeichnung Designation										
	Größe Size										
	00	0	1	2	3	4	5	6	7	8	9
Außen Ø external dia	16	22	29	36	45	60	85	110	145	195	250
Zähnezahl number of teeth	16	16	18	18	18	18	18	18	18	24	30
Abmessungen Designation	Id. Nr. Id. No										
VKT											
2,1	6705614										
2,4	6705615										
2,5	6705616										
2,7	6705617										
3,0	6705618										
3,2	6705619										
3,4	6705620	6705659									
3,5	6705621	6705660									
3,8	6705622	6705661									
4,0	6705623	6705662									
4,3	6705624	6705663									
4,5	6705625	6705664									
4,9	6705626	6705665	6705708								
5,0	6705627	6705666	6705709								
5,5	6705628	6705667	6705710								
6,0	6705629	6705668	6705711								
6,2	6705630	6705669	6705712								
6,5	6705631	6705670	6705713								
7,0	6705632	6705671	6705714								
8,0	6705633	6705672	6705715								
9,0		6705673	6705716								
10,0		6705674	6705717	6705760							
11,0		6705675	6705718	6705761							
12,0			6705719	6705762							
13,0			6705720	6705763							
14,0			6705721	6705764	6705803						
14,5			6705722	6705765	6705804						
15,0				6705766	6705805						
16,0				6705767	6705806						
17,0				6705768	6705807						
18,0				6705769	6705808						
19,0					6705809						
20,0					6705810						
22,0					6705811						

Bestellbeispiel Example for ordering
R1-VKT9,0



Ratschen-Einsatz: Vierkant = VKT
Ratchet Inserts: square = VKT

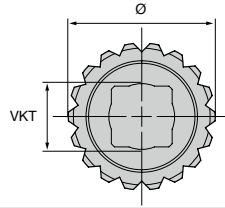

VKT...	Bezeichnung Designation										
	Größe Size										
	00	0	1	2	3	4	5	6	7	8	9
Außen Ø external dia	16	22	29	36	45	60	85	110	145	195	250
Zähnezahl number of teeth	16	16	18	18	18	18	18	18	18	24	30
Abmessungen Designation	Id. Nr. Id. No										
VKT											
18						6705856					
19						6705857	6705937				
20						6705858	6705939				
22						6705859	6705934				
24						6705860	6705935				
25						6705861	6705912				
26						6705862	6705923				
27						6705863	6705913				
28						6705864	6705928				
29						6705865	6705925				
30						6705866	6705914				
32							6705915	6705985			
35							6705916				
36							6705917	6705984			
40							6705918	6705973			
41							6705919	6705974			
46							6705920	6705975	6706022		
50								6705976	6706015		
55								6705977	6706016		
60								6705978	6706017		
65									6706018		
70									6706019		
75											
80									6706020		
85											
90										5010734	
95											
100										6706037	
105											
110											
115										6706038	
135											

auf Anfrage on request

Bestellbeispiel Example for ordering
R1-VKT20

Ratschen-Einsatz: Sechskant = SKT
Ratchet Inserts: hexagon = SKT

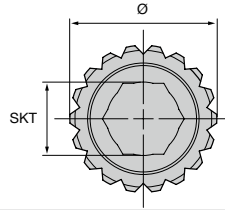

SKT...	Bezeichnung Designation										
	Größe Size										
	00	0	1	2	3	4	5	6	7	8	9
Außen Ø external dia	16	22	29	36	45	60	85	110	145	195	250
Zähnezahl number of teeth	16	16	18	18	18	18	18	18	18	24	30
Abmessungen Designation	Id. Nr. Id. No										
SKT											
3,0	6705646										
3,5	6705647										
4,0	6705648										
4,5	6705649										
5,0	6705650	6705692									
5,5	6705651	6705693									
6,0	6705652	6705694									
7,0	6705653	6705695									
8,0	6705654	6705696	6705736								
9,0	6705655	6705697	6705737								
10,0		6705698	6705738								
11,0		6705699	6705739	6705785							
12,0		6705700	6705740	9196525							
13,0			6705741	6705784							
14,0			6705742	6705777	5017273						
15,0			6705743	6705778							
16,0			6705744	6705779	6705821						
17,0			6705748	6705780	6705822	6705884					
18,0				6705781	6705823						
19,0				6705782	6705824						
20,0				5054888	6705829	6705881					
21,0				6705783	6705825						
22,0					6705826	6705879					
24,0					6705827	6705872					
27,0					6705828	6705873	6705942				
30,0						6705874	6705943				
32,0						6705875	6705944				
36,0						6705876	6705945	6706001			
41,0							6705946	6705996			
46,0							6705947	6705990			
50,0							6705948	6705991			
55,0								6705992			
60,0								6705993	6706024		
65,0								6705994	6706025		
70,0								6705995	6706026		
75,0									6706027		
80,0									6706028		
85,0									6706029	6706039	
90,0									6706030	6706040	
95,0										6706041	
100,0										6706042	6774071
105,0										6706043	6706050
110,0										6706044	
115,0										6706045	
130,0										6706046	
135,0											6706051

Ratschen-Einsatz: Bohrung = D

Bohrung mit Keilnut nach DIN 6885 Bl.1

Ratchet Inserts: bore hole = D

Bore hole with keyway according to DIN 6885 Bl.1

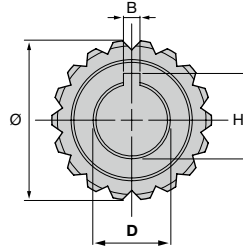

D...			Bezeichnung Designation Größe Size											
			00	0	1	2	3	4	5	6	7	8	9	
Außen Ø external dia			16	22	29	36	45	60	85	110	145	195	250	
Zähnezahl number of teeth			16	16	18	18	18	18	18	18	18	24	30	
Abmessungen Designation			Id. Nr. Id. No											
D	B	H												
10	3	11,4	6705703											
12	4	13,8	6705704	6705751										
14	5	16,3		6705752	6705789									
15	5	17,3		6705749	6705790									
16	5	18,3		6705750	6705787	6705838								
17	5	19,8			6705791									
18	6	20,8			6705788									
19	6	21,8			6705792	6705837								
20	6	22,8				6705833	6705894							
22	6	24,8				6705834	6705890							
24	8	27,3				6705835	6705889							
25	8	28,3					6705885							
28	8	31,3					6705886	6705963						
30	8	33,3					6705887	6705956						
35	10	38,3						6705957						
38	10	41,3						6705964	6706012					
40	12	43,3						6705958	6706002					
45	14	48,8						6705959						
48	14	51,8						6705960	6706009					
50	14	53,8							6706003					
55	16	59,3							9070529	5026639				
60	18	64,4							6706004					
65	18	69,4							6706005					
75	20	79,9									6706031			
80	22	85,4									6706032			
90	25	95,4												
100	28													
110	28													
120	32													

auf Anfrage on request

auf Anfrage on request

Bestellbeispiel Example for ordering
R4-D28



Wir halten, was wir versprechen

Unser qualifiziertes Fachpersonal repariert defekte Induktionsgeräte, Gewindeschneidfutter, Bohrfutter und viele weitere Produkte von BILZ.

Wir bieten einen schnellen und zuverlässigen Service.

Sie erhalten innerhalb von 2 bis 5 Werktagen einen unverbindlichen Kostenvoranschlag, nach Anlieferung Ihres Werkzeuges oder Induktionsgerätes bei BILZ.

fair • schnell • transparent

- Begutachtung Ihres Werkzeuges nach fairen Gesichtspunkten hinsichtlich des Verschleißzustandes
- Sie entscheiden mit – nach Erhalt des Kostenvoranschlags – ob eine Aufbereitung oder Erneuerung sinnvoll ist
- Wenn eine Reparatur aus Kostengründen nicht mehr lohnenswert sein sollte, erhalten Sie ein unverbindliches Angebot für ein neues Produkt
- Schnellstmögliche Reparatur und Rückversand
- Teilen Sie uns Ihre Sonderwünsche mit

Kontaktdaten Service unter:

www.bilz.de/service/service-team/

Contact details service:

www.bilz.de/en/service/service-team/

We hold our promises

Our qualified experts repair defective shrink machines, tapping chucks, drill chucks and many other BILZ products. We offer a fast and reliable service.

You will receive our non-binding cost estimate for the repair within 2 to 5 working days after receipt of your tool or machine at BILZ.

fair • fast • transparent

- fair assessment of your tool's condition
- you decide whether to go ahead with a repair or renewal after receiving our cost estimate
- if the repair is no longer economical, you will receive a non-binding quote for a new product
- repair and return will be carried out as quickly as possible
- please communicate any special requests to us



Programmaktualität

Im Rahmen der kontinuierlichen Aktualisierung unseres Produktprogrammes nehmen wir nicht nur neue und damit technisch bessere Produkte im Programm auf, sondern führen auch eine intensive Programmbereinigung durch. Es kann also im Einzelfall passieren, dass wir einen von Ihnen bestellten Artikel nicht mehr lagermäßig führen. Sie erhalten dann von uns in der Regel ein technologisch besseres Produkt, mindestens aber eine gleichwertige Alternative. In Zweifelsfällen wird sich unser Verkaufsteam mit Ihnen in Verbindung setzen, um eine für Sie optimale Ausführung zu bestimmen. Durch diese Vorgehensweise ist sichergestellt, dass Sie stets mit Werkzeugen beliefert werden, die technisch auf dem neuesten Stand sind.

Eine Verpflichtung zur Lieferung von noch im Katalog oder in der Preisliste abgebildeten Werkzeugen, die intern aber bereits programmbereinigt wurden, übernehmen wir deshalb nicht.

Schreib- und Rechenfehler sind vorbehalten. Maßgeblich sind die Angaben in der Auftragsbestätigung.

Preise

Dieser Katalog enthält keine Preise. Diese entnehmen Sie bitte der jeweils gültigen Preisliste.

Mindestauftragswert

Wir bitten um Verständnis, dass wir Aufträge bis zu einem Gesamtwert unter € 50,- nur gegen eine zusätzliche Bearbeitungsgebühr in Höhe von € 20,- ausführen können.

Die Mindestbestellmenge bei Sonderartikeln beträgt 3 Stück.

Sonderformen

Sollten Sie eines Ihrer Bearbeitungsprobleme nicht mit einem unserer lagergängigen Werkzeuge lösen können, bieten wir Ihnen Sonderformen oder zeichnungsgebundene Werkzeuge auf Anfrage an. Unsere Anwendungstechniker beraten Sie gern.

Updating of our product range

In the course of updating of our product range, we are not only constantly adding new and therefore technically improved products to our programme, but at the same time are also continually reassessing the product range. In exceptional cases, it can therefore happen that we no longer have a product you order on stock.

You will then receive a technically improved product or at least an equivalent alternative. In case of doubt, our sales team will contact you in order to determine the optimal version for you. We ensure that you will always get the most updated tools.

We therefore do not assume any obligation to supply tools appearing in the catalogue and/or in the price list which have already been adjusted out of the system internally.

Bilz and its partners shall have no liability for indirect, incidental or consequential errors in this catalog.

Some mistakes and calculation errors may be present. Orders are subject to approval.

Prices

For prices, please refer to the current price list.

Minimum order value

An additional handling fee of EUR 20.00 will be charged for orders with a total value of less than EUR 50.00.

The minimum order quantity for special tools is 3 pcs.

Special designs

If you find that your specific machining problems cannot be resolved with any of our permanently stocked tools, then we can supply special designs or tools made according to drawings. Our application technicians will be glad to help you.

Nachdruck, auch auszugsweise, ist nur mit unserer Zustimmung gestattet. Alle Rechte vorbehalten. Irrtümer, Satz- oder Druckfehler berechtigen nicht zu irgendwelchen Ansprüchen. Abbildungen, Ausführungen und Maße entsprechen dem neuesten Stand bei Herausgabe dieser Druckschrift. Technische Änderungen müssen vorbehalten sein. Die bildliche Darstellung der Produkte muss nicht in jedem Falle und in allen Einzelheiten dem tatsächlichen Aussehen entsprechen.

This publication may not be reprinted in whole or part without our permission. All rights reserved. No rights may be derived from any errors in content or from typographical or typesetting errors. Diagrams, features and dimensions represent the current status on the date of issue of this leaflet. We reserve the right to make technical changes. The visual appearance of the products may not necessarily correspond to the actual appearance in all cases or in every detail.



**BILZ WERKZEUGFABRIK
GmbH & Co. KG**
Vogelsangstr. 8
73760 Ostfildern
Deutschland/Germany
Telefon +49 711 348 01 -0
Telefax +49 711 348 12 56
info@bilz.de
www.bilz.de



*Produktions- und Vertriebsstandorte der LEITZ-Group
Production and sales locations of the LEITZ Group*

- **Bilz**
- **Boehlerit**
- **Leitz**